



The Bose® 131™ Marine Speaker System

Owner's Guide

October 30, 2001

AM188201_02_V.pdf

Please read this owner's guide

The Bose® 131™ marine speaker system is engineered to provide sound quality far beyond other marine speaker systems. This guide helps you install and use your speaker system properly. **Please read the installation section completely before cutting any holes.** It is important to understand the reasons for choosing one mounting hole size over the other.

Warranty period

Bose 131 marine speakers are covered by a limited 3-year transferable warranty. Details of the coverage are provided on the warranty card that came with your speakers. Please fill out the information section on your card. Then detach the card, and mail it to Bose Corporation.

Technical information

Features

- Polymer fiber driver cone
- Dual-port polypropylene enclosure
- Syncom II® computer quality control

Speaker driver complement

- One 4½" (11.4 cm) full range environmental driver per enclosure

Compatibility/Impedance

- Maximum continuous power per I.E.C.: 40W
- Compatible with receivers or amplifiers
10 - 80 watts per channel
- Impedance 4 - 8 ohms

Finish

- Grille: Arctic White

Size/Dimensions

- Weight, unpacked: 9 lb (4 kg)
- 12"L x 3½"D (30 cm x 8.9 cm)
- Cut out Diameter:
 - 5⅜" (13.7 cm) with access to rear of mounting surface
 - 7⅛" (18 cm) without access to rear of mounting surface
- Grille Diameter: 8" (21 cm)
- Mounting Depth: 3½" (8.9 cm)
- Mounting Wall Thickness:
 - .75" (1.9 cm maximum) rear mounting
 - .50" (1.2 cm maximum) front mounting

For your records...

Serial numbers are located on the label of each 131 marine speaker.

Serial numbers: _____ and _____

Dealer name: _____

Dealer phone: _____ Purchase date: _____

We suggest you keep your sales slip and warranty card together with this owner's guide.

Where to find...

Setting up
 Unpack the carton 4
 Tools required 4
 Select the locations for your speakers 5

Installing Your Speakers
 Test the speakers 6
 Mounting the speakers 6
 Installation from the rear of the bulkhead 7
 Installation from the front of the bulkhead 11

Maintaining Your Speakers
 Cleaning the speakers 16
 Troubleshooting 16

Bose® Corporation inside back cover



DECLARATION OF CONFORMITY

We, the offerer:

Bose® Corporation, The Mountain,
 Framingham, MA 01701-9168 USA

acknowledge our sole responsibility, that the product:

Kind of equipment: Loudspeaker
Type designation: 131™ marine speaker system

in accordance with EMC Directive 89/336/EEC
 and Article 10(1) of the Directive,
 is in compliance with the following norm(s) or document(s):

Technical regulations: EN50081-1, EN50082-1
 Accredited by Bose Corporation

23 January 1997
 Bose B.V.
 Nijverheidstraat 8, 1135 GE Edam
 The Netherlands

 Anton Schalkamp
 General Manager, Bose Europe
 Manufacturer's authorized EU representative

Unpack the carton

Carefully unpack your speakers and save all packing materials for possible future use. Do not attempt to use your speaker system if any part of it appears damaged. Notify Bose® Corporation or your authorized Bose dealer immediately. Check that your system contains the parts identified in Figure 1. For shipping, the mounting flange is packed inside its speaker grille. Separate these components before installation.

- ♪ *Notes: Please remove the perforated drilling and cutting template from the inner carton containing the grille and mounting flange. Also remove the perforated speaker cone shields from the inner cartons containing the enclosures. You will need the template and shields during installation.*

Now is a good time to record each speaker serial number on page 2 of this guide and on your warranty card.

- ⚠ **CAUTION:** *The 131™ marine speakers are not intended to be installed in automobiles.*

Figure 1

Packaging Contents:

- Two 131 marine speaker enclosures
- Two mounting flanges
- Two speaker grilles
- One Owner's Guide
- One template for positioning, cutting, and drilling holes
- Two speaker cone shields
- Mounting hardware:
 - 30 screws (6 extra)
 - 10 wire nut connectors (2 extra)
 - Two 20 foot speaker cables, 18-gauge

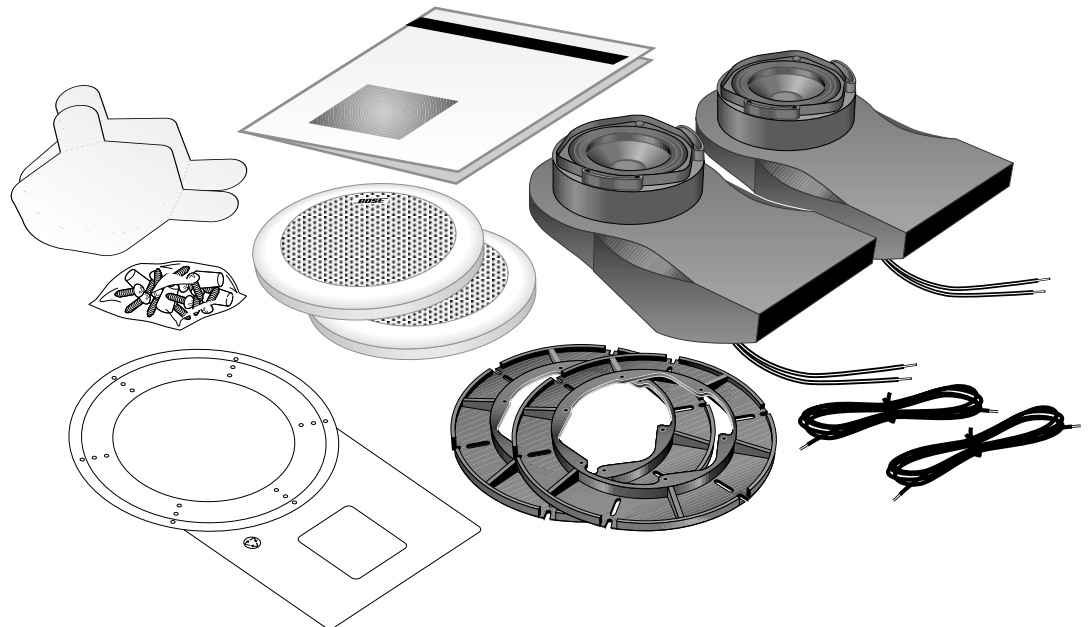

Tools required

You will need the following tools to complete this installation:

- Phillips-head screwdriver.
- An appropriate cutting tool for the surface to be cut. For installation in fiberglass or wood, we recommend a sabre saw. Use a short blade, and have some extra blades available. A hole saw may also be used. Large diameter hole saws are available and they allow you to make circular cuts on a flat surface.
- Drill with the following bits:
 - For drilling the screw holes a $\frac{3}{32}$ inch (.24 cm) bit is preferred, but you could also use a $\frac{1}{8}$ (.32 cm) inch bit.
 - For drilling the starter hole, use a $\frac{5}{16}$ inch (.8 cm) bit.
- Center punch or awl.
- Half-round file or rasp.
- Eye and ear protection; dust mask.

- ⚠ **CAUTION:** *Failure to follow these instructions voids all warranties on your speakers. If you are unsure of your ability to complete this process, consult a professional installer. Please read this owner's guide completely before beginning installation.*

Select the locations for your speakers

In selecting locations for your speakers, understand that there are two possible mounting options. It is easiest to mount the speakers from behind the mounting surface. However, if you cannot reach behind the mounting surface, you may cut a larger hole that allows you to insert the speaker enclosure from the front of the mounting surface. See Figure 2. With this in mind, find a location that:

- Allows sufficient room to snap on the grille. Use the template to be sure there is enough area around the holes you will cut in the bulkhead.
- Allows sufficient room for the speaker enclosure behind the bulkhead. During installation, the enclosure requires 4½ inches (11 cm) of mounting depth. However, once installed the enclosure requires only 3½ inches (9 cm) of mounting depth and 12 inches (31 cm) of extension. The enclosure may be rotated in a complete circle, but attaches to the mounting flange in only one position.
- Accommodates the speaker wire provided. Lay out lengths of wire that comfortably reach from the receiver to each speaker. Be sure the wires are secure and protected from being pinched, pulled, or damaged in any way.
- Is not close enough to adversely affect any compass.

♪ *Note: The magnets in the speakers will affect a boat compass. Avoid mounting the speakers closer than three feet from the compass. If necessary, a marine installer can help correct any deviation.*

Figure 2

Selecting the right locations

A. Mount from the rear if you can insert the speaker enclosure behind the bulkhead mounting surface.

B. Mount from the front if you cannot reach behind the mounting surface. If you are uncertain about the depth and clearance behind your mounting surface, consult your boat manufacturer or dealer.

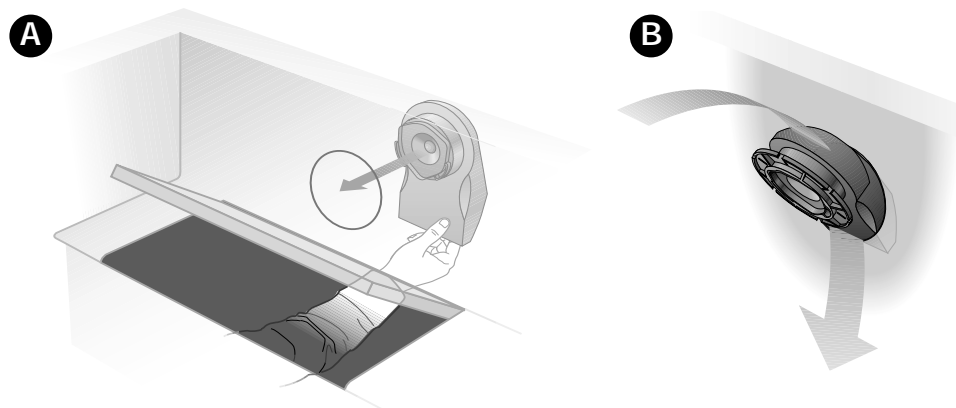

♪ *Note: Before going any further with your assembly, choose one of the methods described in Figure 2 above. The instructions for A begin on page 7; B on page 11.*

Test the speakers

It is a good idea to test your system before installation. With the power turned off, connect the receiver to the speakers.

The provided speaker cord consists of two insulated wires; one is marked or ribbed, and is always positive (+). The plain wire is always negative (-). The wires correspond to the red (+) and black (-) terminals on the back of the speaker, receiver, or amplifier. Place the stripped end of the positive (+) right channel receiver wire together with the stripped end of the positive (+) right speaker wire. Then place the stripped end of the negative right channel receiver wire together with the stripped end of the negative right speaker wire. Repeat this procedure for the left speaker.

Be sure to connect each wire to the proper terminal (positive to positive, negative to negative). For this test, just twist the wire ends together. You will use the supplied wire nuts for the permanent connections.

When you are satisfied that everything works, disconnect the speakers and continue with the installation.

Mounting the speakers

⚠ CAUTION: Be sure to mount your 131™ marine speakers on a bulkhead only. Do not cut holes in the hull. We recommend you consult a marine installer before drilling or cutting any holes. Choose a safe spot for drilling. Do not mount the speakers on surfaces with concealed hazards, such as electrical conduits or plumbing.

The cutting and drilling template

Locate the cutting and drilling template. It is perforated into the inner carton that contained your grilles and mounting flanges. The template has four functions.

1. It helps you position the speaker enclosure by showing how much room to provide for the extension of the enclosure behind the bulkhead.
2. It shows you how much room to allow for the snap on grille.
3. It assists you in cutting the appropriate hole size in the bulkhead wall.
4. It helps you drill the mounting screw holes in the bulkhead.

The template has two punch-out hole diameters. Use the smaller size for installation from behind the bulkhead. Use the larger for installation from the front. See Figures 2 & 3.

Figure 3

The template

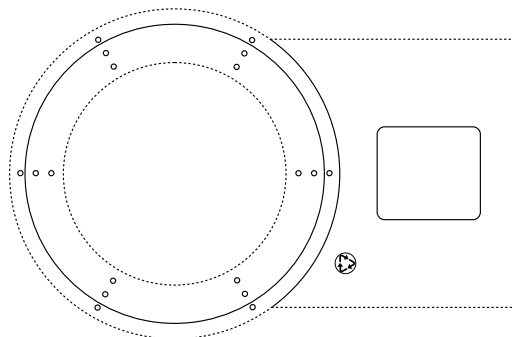

A Installation from the rear of the bulkhead

Choose the 5³/₈ inch (13.6 cm) diameter hole size if you can comfortably hold the speaker enclosure from behind the wall while installing screws from the front. This is the preferred mounting method. If the hole you cut is not perfect, any slight overcut will be hidden by the grille.

- A 1** Determine that there is enough room by reaching into the mounting area and sweeping with your hand. Determine where you will drill the hole for the speaker. You should also experiment by placing the speaker enclosure behind the bulkhead before making your final selection. Any orientation of the speaker enclosure is acceptable.

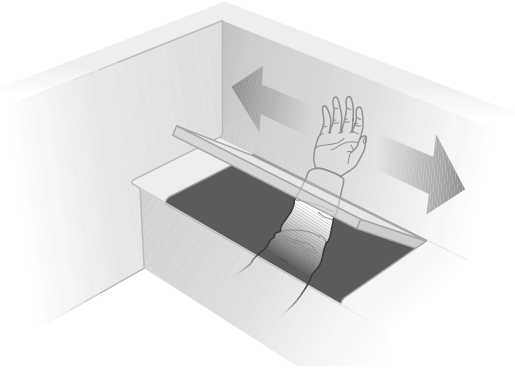

- ⚠ CAUTION:** Determine whether any obstacles exist behind the mounting surface. To be certain, contact your boat manufacturer or dealer. Also, be certain that the enclosure will fit within the mounting area before drilling any holes.

- A 2** The round outer edge of the template shows how much room to allow for the grille. The long end is used to plan for room for the enclosure behind the bulkhead. There are two perforated circles in the template. Snap out the smaller one.

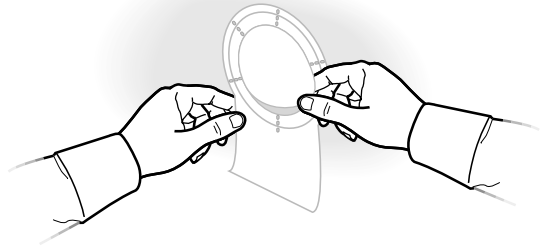

- A 3** Place the template over the area where the speaker is to be located and mark the 5³/₈ inch (13.6 cm) hole with a metal scribing tool or pencil.

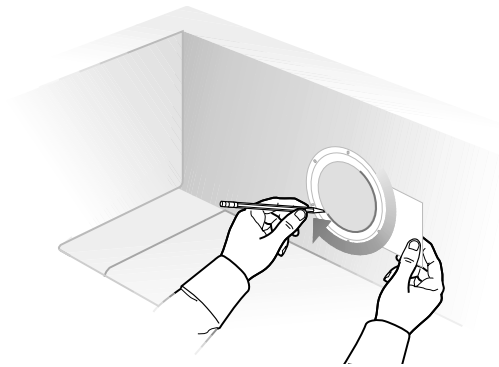

- A 4** Drill a starter hole that is large enough for your sabre saw blade. Be sure to drill inside and close to the line you have marked.

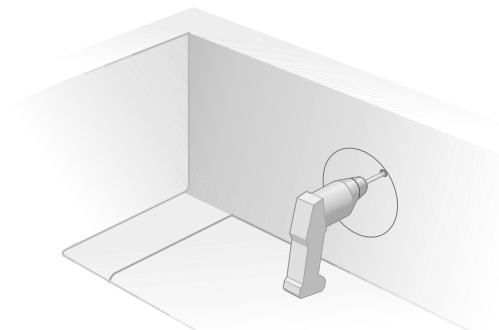

- A 5** Using the sabre saw, cut the hole for the speaker, carefully following the line. Take your time; you want a smooth-edged circular hole.

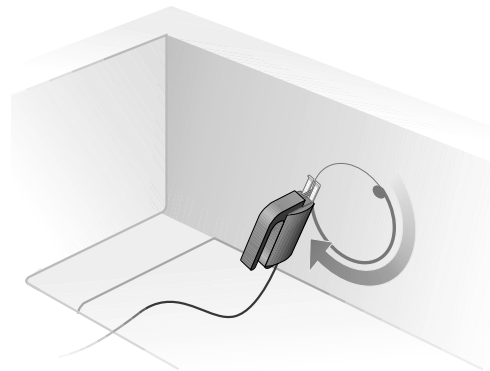

- A 6** Use a half-round file or wood rasp to smooth out any roughness in the hole you have cut.

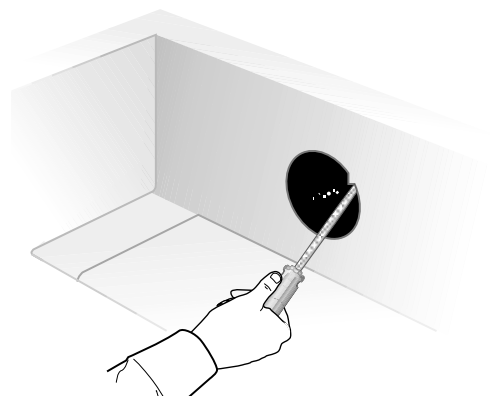

- A 7** Hold the speaker enclosure up to the hole from behind the bulkhead and find the best position for the extended portion of the enclosure. Be sure the enclosure is hidden behind the bulkhead. If the enclosure does not fit, use the file or rasp to enlarge the hole.

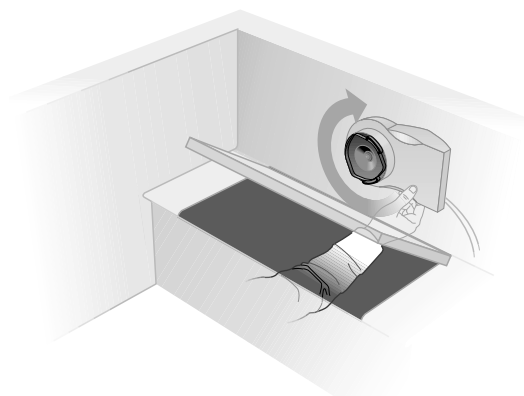

- A 8** Place the mounting flange so that it interlocks with the enclosure and is flush with the mounting surface.

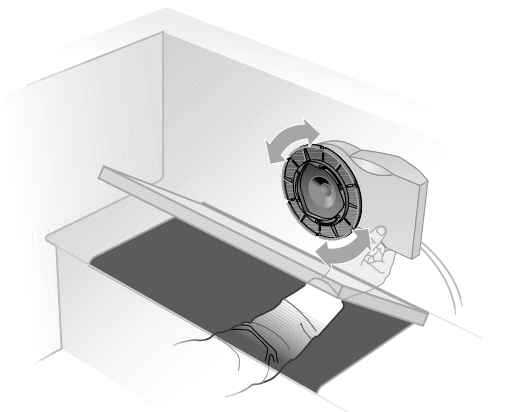

- A 9** Mark six screw holes. Use the smallest hole pattern that fits.

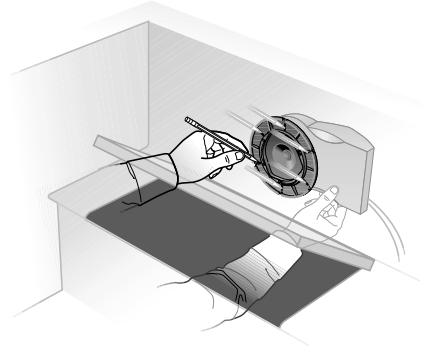

- A 10** Remove the enclosure from behind the bulkhead.

⚠ CAUTION: Be sure the enclosure is not in place behind the bulkhead while drilling.

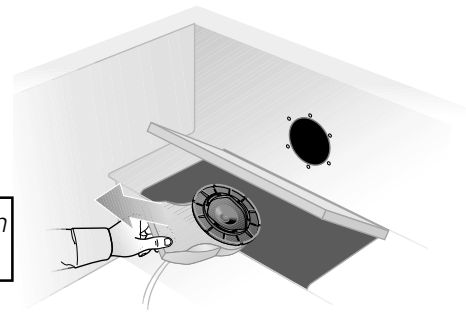

- A 11** Drill the marked holes using a 1/8 inch (.32 cm) bit. Use a center punch to make a slight indentation for your drill bit. This will keep the drill bit from "walking" away from the mark you have made.

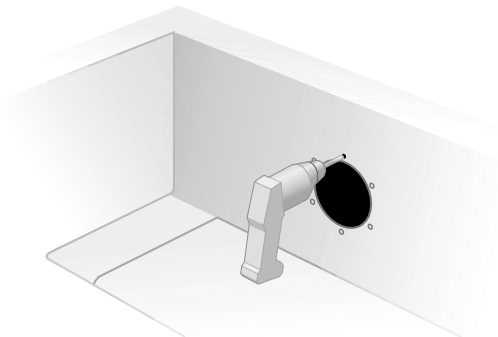

- A 12** You need to open *one* of the five marked drain holes because water can enter your 131™ marine speaker through the ports on the front of the enclosure.

Holding the enclosure in the mounting position you chose in Step 7, find the drain hole that will be at the *lowest* point when the speaker is mounted and break through the surface using a center punch, awl, or 1/8 inch (.32 cm) drill bit.

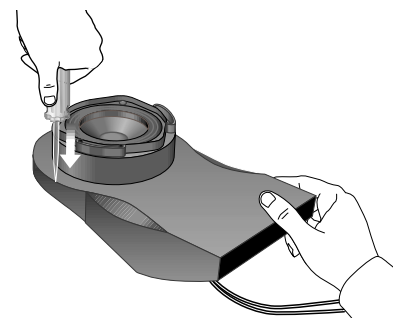

⚠ CAUTION: Acoustic performance is reduced if the hole is larger than 1/8 inch (.32 cm) in diameter.

- A 13** Connect the speakers. Be sure the receiver or amplifier is turned OFF. If possible, disconnect the power source. Use the supplied silicone-filled wire nuts to secure the ends of each wire pair. Place the stripped end of the positive (+) right channel receiver wire together with the stripped end of the positive (+) right speaker wire. Place the wire nut over the ends of the wires and turn it in a clockwise direction. Turn it with firm pressure until it stops; there should be no uninsulated wire visible. Repeat this procedure for the remaining wire end.

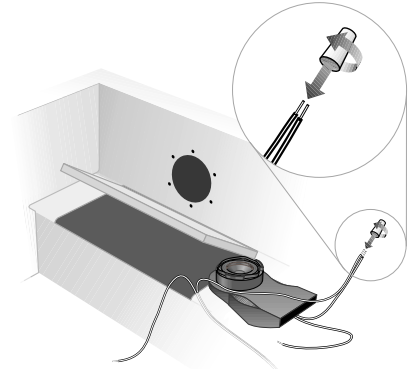

Repeat the above procedure for the left speaker.

Check that all connections are made positive to positive (+ to +) and negative to negative (- to -). Tighten any loose connections before you plug in the receiver or amplifier and turn it on.

-  *Note: Twisting the ends of the wires together is not necessary.*

- A 14** Tie a knot in each joined wire pair to protect the connection from being pulled apart.

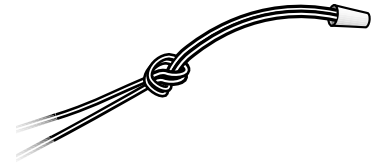

- A 15** Remove the perforated speaker cone shields from the enclosure cartons. Insert the tabs of the shields into the speaker ports. This helps protect the speaker cone from potential damage during the installation process.

-  *Note: For added protection against water entering the bulkhead, you can apply a generic silicone sealant between the flange and the mounting surface.*

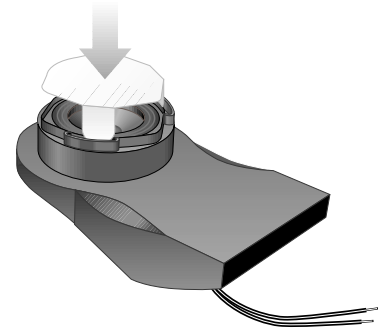

- A 16** Replace the enclosure behind the bulk head and place the mounting flange so that it interlocks with the enclosure and lines up with the drilled holes. Attach the flange to the mounting surface using six screws. Next, install six screws through the flange into the matching holes in the enclosure.

-  *Note: If you plan to use a screw gun to install the screws, you should first set the gun to its lowest torque setting (do not exceed 12 inch-pounds or 135.84 N-cm of torque). If the screw does not seat properly, finish installing the screw at the next highest torque setting, or by hand.*

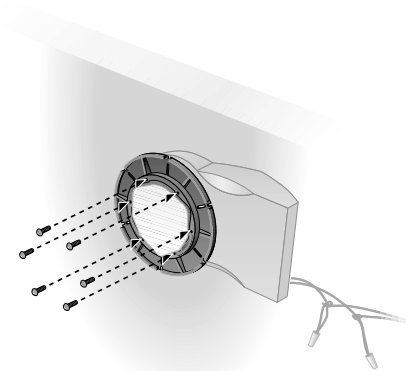

- A 17** Remove the speaker cone shield from the enclosure.

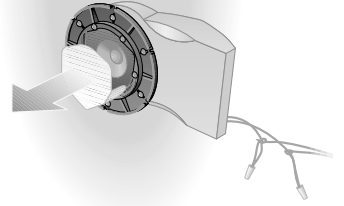

- A 18** Snap the grille in place on the mounting flange. No hardware is needed to secure this part. You are now finished with the assembly. Enjoy your music system!

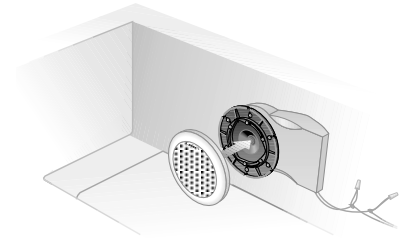

B Installation from the front of the bulkhead

If you cannot reach the mounting area from behind the bulkhead, you will have to mount the speaker enclosure by inserting it through the front. To do this you will need a $7\frac{1}{8}$ inch (18 cm) hole, the larger of the two perforated sections on your template.

- ⚠ CAUTION:** Determine whether any obstacles exist behind the mounting surface. To be certain, contact your boat manufacturer or dealer. Also, be certain that the enclosure will fit within the mounting area before drilling any holes.

- B 1** Place the template over the area where the speaker is to be located. The round outer edge shows how much room to allow for the grille. The long end is used to judge the room needed behind the bulkhead. There are two perforated circles in the template. Snap out the larger one and mark the $7\frac{1}{8}$ inch (18 cm) hole with a metal scribing tool or pencil.

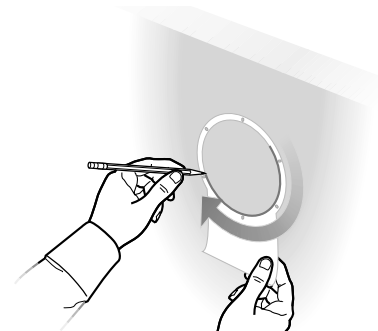
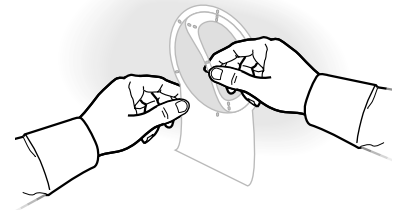

- B 2** Mark six screw holes from the largest hole pattern on the template, **but do not drill yet**. You may need to mark and drill a different set of holes along the same circle before finally attaching the flange.

♪ *Note: These markings are important to help keep the saw blade inside the line you have just drawn.*

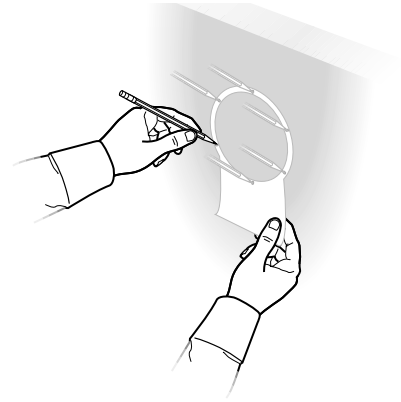

- B 3** Drill a starter hole that is large enough for your sabre saw blade. Be sure to drill inside and close to the line you have marked.

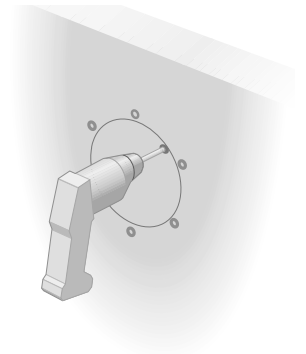

- B 4** Using the sabre saw, cut the hole for the speaker, carefully staying just inside the line. Take your time; you want a smooth edged circular hole.



CAUTION: Be sure to stay inside the line you have marked, and in particular, be sure to stay well inside the hole pattern you have marked. The marked holes, or others along the same circle, will be used to secure the speaker and must not be too close to the speaker hole. It is also important to stay inside the line because any error you make could be visible after the speaker grille is installed.

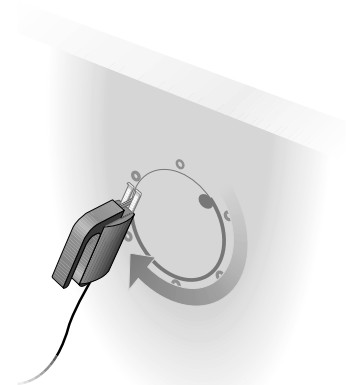

- B 5** Use a half-round file or wood rasp to smooth out any roughness in the speaker hole you have cut.

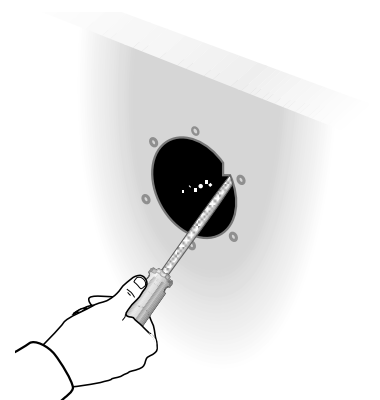

- B 6** Attach the mounting flange to the enclosure using six screws.

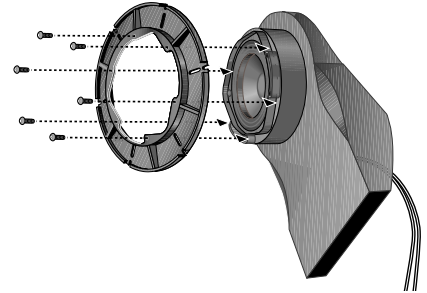

- B 7** Slide this assembly into the 7 $\frac{1}{8}$ inch (18 cm) hole and rotate the enclosure a full 360° to determine the best mounting position for the extended portion of the speaker enclosure.

When you have determined the best position, take a moment to make careful note of it. Then, remove the speaker enclosure.

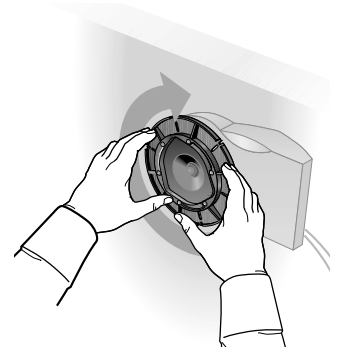

- B 8** You will need to open *one* of the five marked drain holes because water can enter your 131™ marine speaker through the ports on the front of the enclosure.

Holding the enclosure in the mounting position you chose in Step 7, find the drain hole that will be at the *lowest* point when the speaker is mounted and break through the surface using a center punch, awl, or $\frac{1}{8}$ inch (.32 cm) drill bit. Completing this task may require you to temporarily remove the flange from the enclosure.

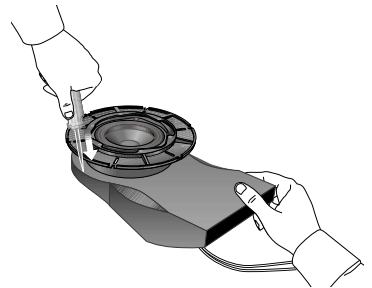

- ⚠** **CAUTION:** Acoustic performance is reduced if the hole is larger than $\frac{1}{8}$ inch (.32 cm).

- B 9** Connect the speakers. Be sure the receiver or amplifier is turned OFF. If possible, disconnect the power source.

Use the supplied silicone-filled wire nuts to secure the ends of each wire pair. Place the stripped end of the positive (+) right channel receiver wire together with the stripped end of the positive (+) right speaker wire. Place the wire nut over the ends of the wires and turn it in a clockwise direction. Turn it with firm pressure until it stops; there should be no uninsulated wire visible. Repeat this procedure for the remaining wire end.

Repeat the above procedure for the left speaker.

Check that all connections are made positive to positive (+ to +) and negative to negative (- to -). Tighten any loose connections before you plug in the receiver or amplifier and turn it on.

- 🎵** *Note: Twisting the ends of the wires together is not necessary.*

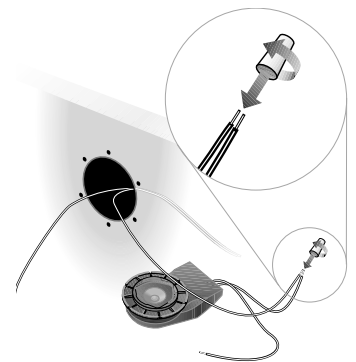

- B 10** Tie a knot in each joined wire pair to protect the connection from being pulled apart.

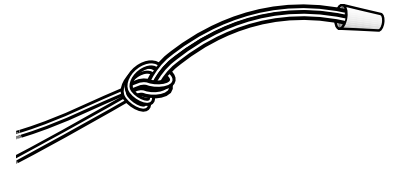

- B 11** Reinsert the enclosure into the wall in the position you determined in Step 7. If the outside circle of holes in the mounting flange line up with the ones you originally marked, remove the enclosure and drill at these marks. If they do not, make new markings that you can differentiate from your original set of markings.

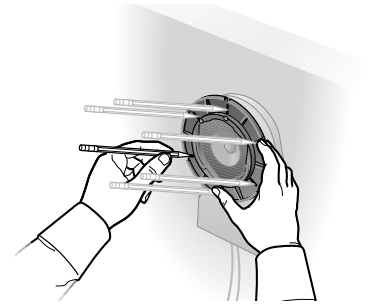

- B 12** Remove the speaker enclosure.

! *CAUTION: Do not drill while the speaker enclosure is in place.*

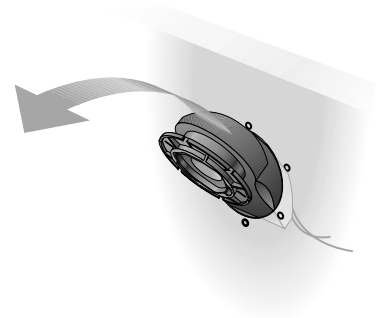

- B 13** Drill six 1/8 inch (.32 cm) holes.

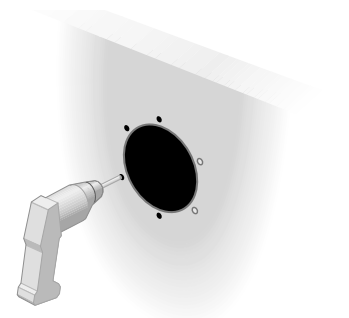

- B 14** Reinsert the speaker enclosure.

♪ *Note: For added protection against water entering the bulkhead, you can apply a generic silicone sealant between the flange and the mounting surface.*

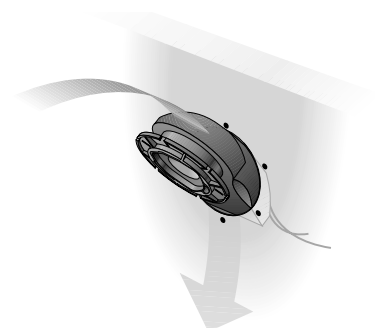

- B 15** Remove the perforated speaker cone shields from the enclosure cartons. Insert the tabs of the shields into the speaker ports. This helps protect the speaker cone from potential damage during the installation process.

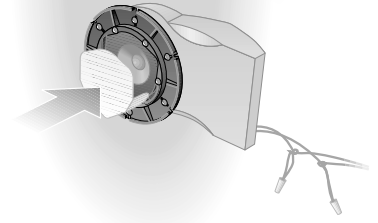

- B 16** Install six screws, if possible. You need at least three screws installed and equally spaced.

♪ Note: If you plan to use a screw gun to install the screws, you should first set the gun to its lowest torque setting (do not exceed 12 inch-pounds or 135.84 N-cm of torque). If the screw does not seat properly, finish installing the screw at the next highest torque setting, or by hand.

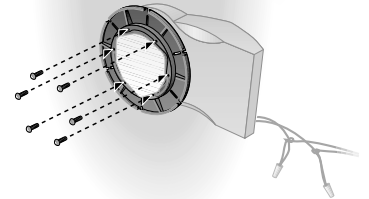

- B 17** Remove the speaker cone shield from the enclosure.

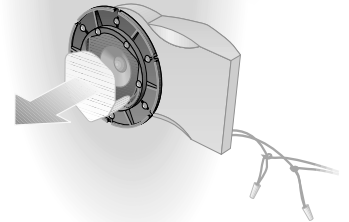

- B 18** Finally, snap on the grille to the mounting flange. No hardware is needed to secure this part. You are now finished with the assembly. Enjoy your music system!

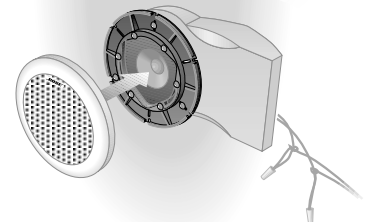

Cleaning the speakers

Wipe the grilles using a soft cloth dampened with a mild detergent, such as dish soap. When cleaning near the speakers with a hose, be careful to avoid forcing water behind the grille, onto the driver, or into the acoustic ports.

No other regular maintenance is required.

Troubleshooting

If you have a problem with your 131™ marine speakers, turn off your sound source and try the solutions below. If one of these solutions does not solve your problem, contact your Bose® dealer to arrange for service. Or, to contact Bose directly, refer to the inside back cover of this guide. Bose Corporation will make every effort to remedy any problem within the terms of your warranty.

<i>Problem</i>	<i>What to do</i>
No sound	<ul style="list-style-type: none"> • Make sure the boat's receiver is turned ON. • Make sure the power supply of the boat is connected and adequately charged. • Make sure the receiver is not set to MUTE. • Refer to the owner's guide that came with your receiver. • Check connections to both the speakers and the receiver. Refer to "Test the speakers" on page 6. Correct any connection errors.
No sound from one speaker	<ul style="list-style-type: none"> • Disconnect the working speaker from the receiver. • Switch the cord of the "faulty" speaker from its original receiver connections to the other set of connections (the working speaker was originally attached to those connections). <ul style="list-style-type: none"> – If the speaker now works, the problem is in your receiver. – If the speaker does not work, continue below. • Remove the cord from the working speaker and connect it to the "faulty" speaker and either set of receiver connections. <ul style="list-style-type: none"> – If the speaker now works, the problem is in the original speaker cord. – If the speaker does not work, the problem is in the speaker.
One speaker sounds distorted	<ul style="list-style-type: none"> • Follow the same procedure for the problem of no sound from one speaker, as outlined above.
Not enough bass or treble	<ul style="list-style-type: none"> • Adjust the bass and treble controls on the receiver. • Check the connections to make sure they are correctly in phase (+ to + and - to -). Refer to "Test the speakers" on page 6.

USA

Bose Corporation, The Mountain
 Framingham, MA 01701-9168
 1-800-367-4008
 Phone hours - ET (eastern time):
 Weekdays 8:30 a.m. to 8 p.m.
 Saturdays 9 a.m. to 3 p.m.

Canada

Bose Ltd., 1-35 East Beaver Creek Road
 Richmond Hill, Ontario L4B 1B3
 1-800-465-2673
 Phone hours - ET (eastern time):
 Weekdays 9 a.m. to 5 p.m.

European Office

Bose Products B.V., Nijverheidstraat 8
 1135 GE Edam, Nederland
 TEL 0299-390111 FAX 0299-390114

Australia

Bose Australia, Inc., 1 Sorrell Street
 Parramatta, N.S.W. 2150
 TEL 02 204-6111 FAX 02 204-6122

Belgique/België

Bose N.V., Limesweg 2, B-3700 Tongeren
 TEL 012-390800 FAX 012-390840

Danmark

Bose A/S, Industrivej 7, 2605 Brøndby
 TEL 4343-7777 FAX 4343-7818

Deutschland

Bose GmbH, Max-Planck-Straße 36d
 D-61381 Friedrichsdorf
 TEL 06172-71040 FAX 06172-710419

France

Bose S.A., 6, rue Saint Vincent
 78100 Saint Germain en Laye
 TEL 01-30616363 FAX 01-30614105

India

Bose Corporation India Private Limited
 W-16, Greater Kailash-II
 New Delhi 110 048
 TEL (011) 648 4462 FAX (011) 648 4463

Ireland

Bose Corporation
 Carrickmacross, Co Monaghan
 TEL (042) 9661988 FAX (042) 9661998

Italia

Bose S.p.A., Via della Magliana 876
 00148 Roma
 www.bose.it
 TEL 06-65670802 FAX 06-65680167

Japan

Bose K.K., Shibuya YT Building
 28-3 Maruyama-cho
 Shibuya-ku, Tokyo 150
 TEL 3-5489-0955 FAX 3-5489-0592

Nederland

Bose B.V., Nijverheidstraat 8
 1135 GE Edam
 TEL 0299-390111 FAX 0299-390109

Norge

Bose A/S, Solheimsgate 11
 N-2001, Lillestrøm
 TEL 63-817380 FAX 63-810819

Österreich

Bose Ges.m.b.H., Vienna Business Park
 Wienerbergstrasse 7 (10.OG)
 A-1100 Vienna
 TEL 01-60404340 FAX 01-604043423

Schweiz

Bose AG, Rünenbergerstrasse 13
 4460-Gelterkinden
 TEL 061-9815544 FAX 061-9815502

Sverige

Bose A/S, JohanneFredsgatan 4
 S-43153 Mölndal
 TEL 31-878850 FAX 31-274891

United Kingdom

Bose Limited
 1 Ambley Green
 Gillingham Business Park
 Gillingham, Kent ME8 ONJ
 TEL 0870-741-4500 FAX 0870-741-4545

From other locations

Bose Customer Service, 1 New York Ave.
 Framingham, MA 01701-9168 USA
 TEL (508) 766-1900 FAX (508) 766-1919

World Wide Web

www.bose.com



BOSE[®]
Better sound through research.[®]

©2000 Bose Corporation
The Mountain, Framingham, MA 01701-9168 USA
188201 AM Rev.02 JN97843