

2.0 Set

2 wireless Speakers

Smart Vento 9
oder
Smart Vento 3
oder
Smart Soundbox 3

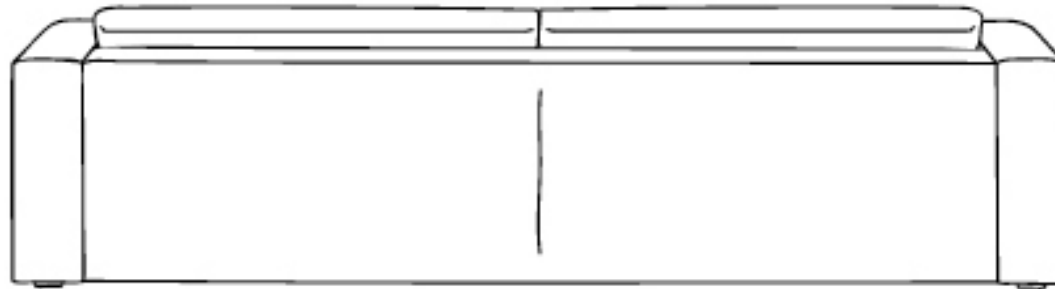
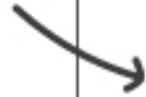

2.1.2 Set

2 wireless Speakers + 2 Atmos Speakers

1 wireless Subwoofer

Smart Soundbar 9

oder

Smart Soundbar 10

Smart Sub 8

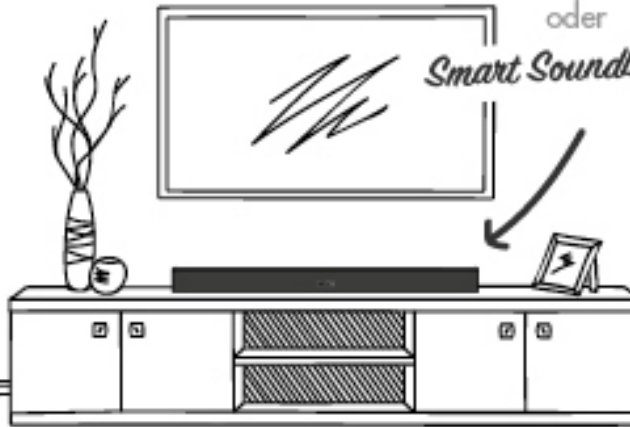

2.1 Set

2 wireless Speakers
1 wireless Subwoofer

Smart Vento 9
oder
Smart Vento 3
oder
Smart Soundbox 3

Smart Sub 8



3.0 Set

3 wireless Speakers

Smart Vento 9
oder
Smart Vento 3
oder
Smart Soundbox 3

Smart Soundbar 10

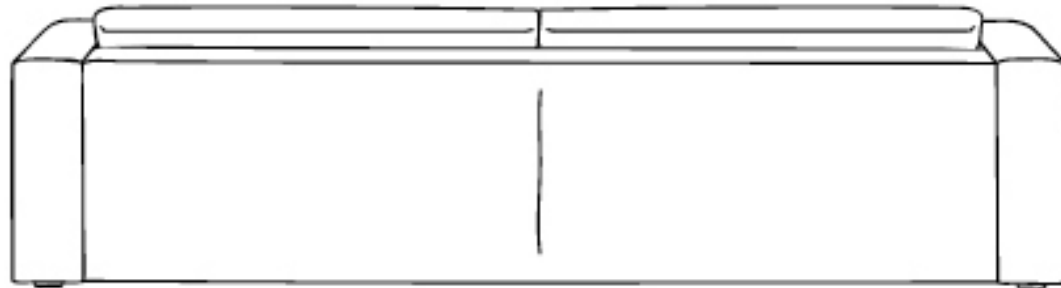
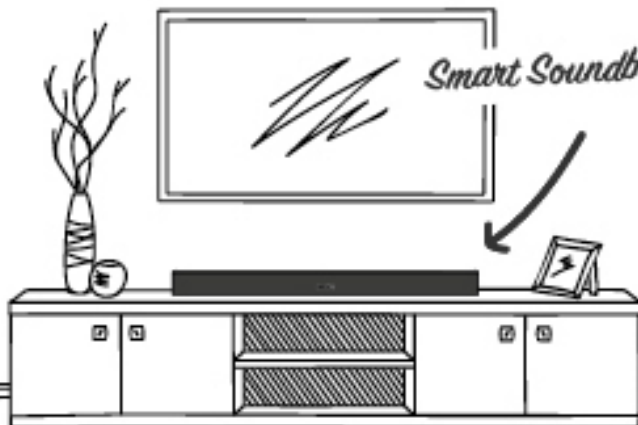
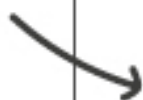

3.1.2 Set

3 wireless Speakers
2 wireless Atmos Speakers

Smart Vento 9
oder
Smart Vento 3
oder
Smart Soundbox 3

Smart Soundbar 10

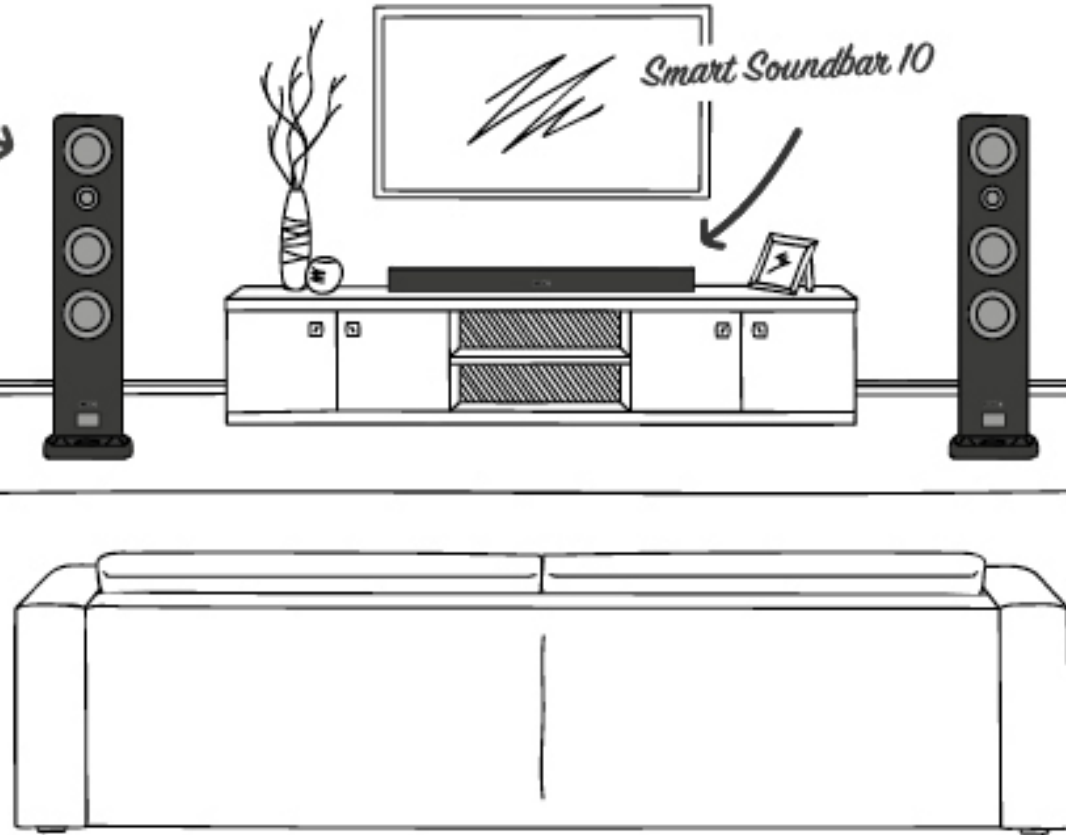

3.1.2 Set

2 wireless Speakers + 2 Atmos Speakers
1 wireless Subwoofer

Smart Vento 9
oder
Smart Vento 3
oder
Smart Soundbox 3

Smart Soundbar 10

Smart Sub 8

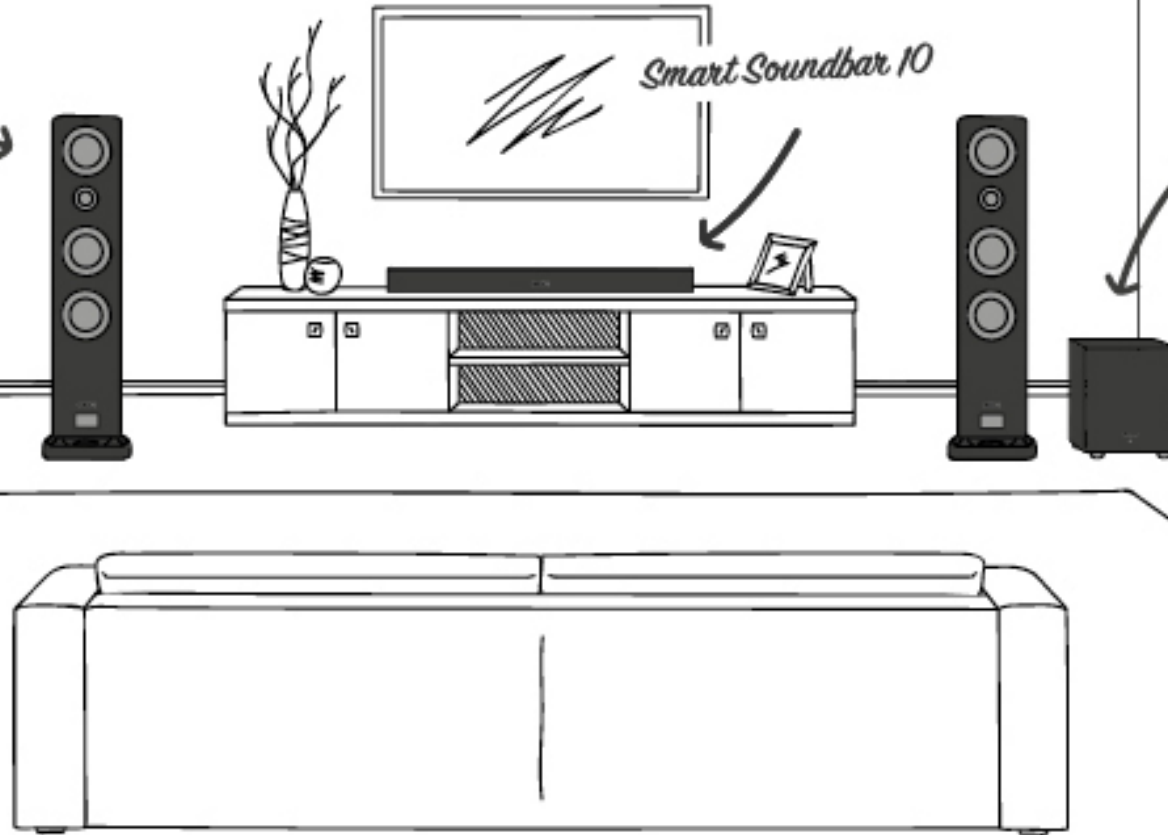

4.0 Set

4 wireless Speakers

Smart Vento 9
oder
Smart Vento 3
oder
Smart Soundbox 3

Smart Vento 9
oder
Smart Vento 3
oder
Smart Soundbox 3

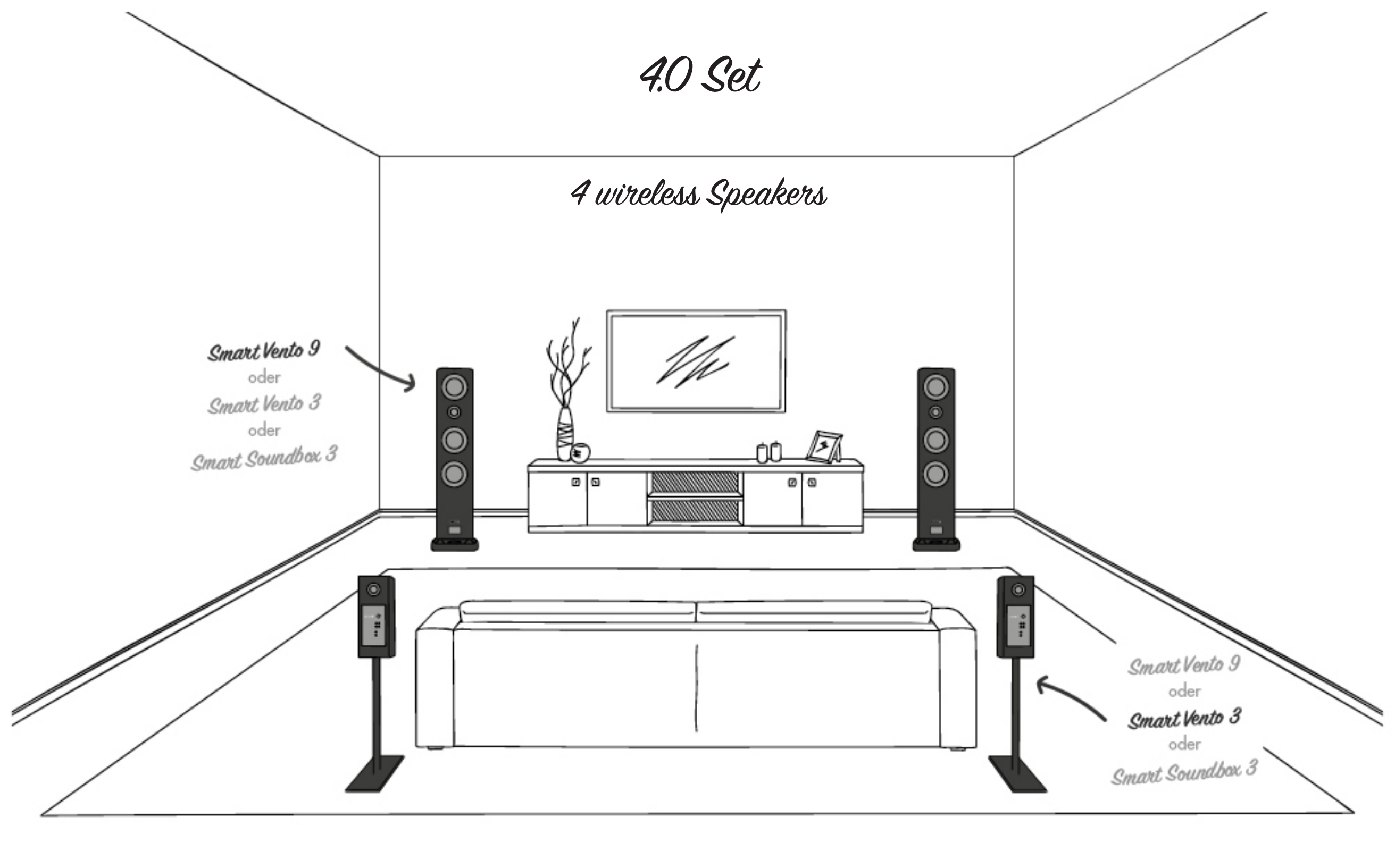

4.1.2 Set

4 wireless Speakers

2 wireless Atmos Speakers

Smart Soundbar 9
oder
Smart Soundbar 10

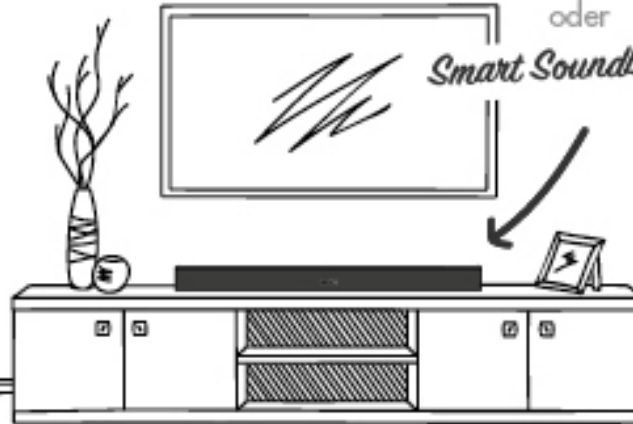

Smart Vento 9
oder
Smart Vento 3
oder
Smart Soundbox 3

4.1.2 Set

4 wireless Speakers + 2 Atmos Speakers

1 wireless Subwoofer

Smart Soundbar 9
oder
Smart Soundbar 10

Smart Sub 8

Smart Vento 9
oder
Smart Vento 3
oder
Smart Soundbox 3

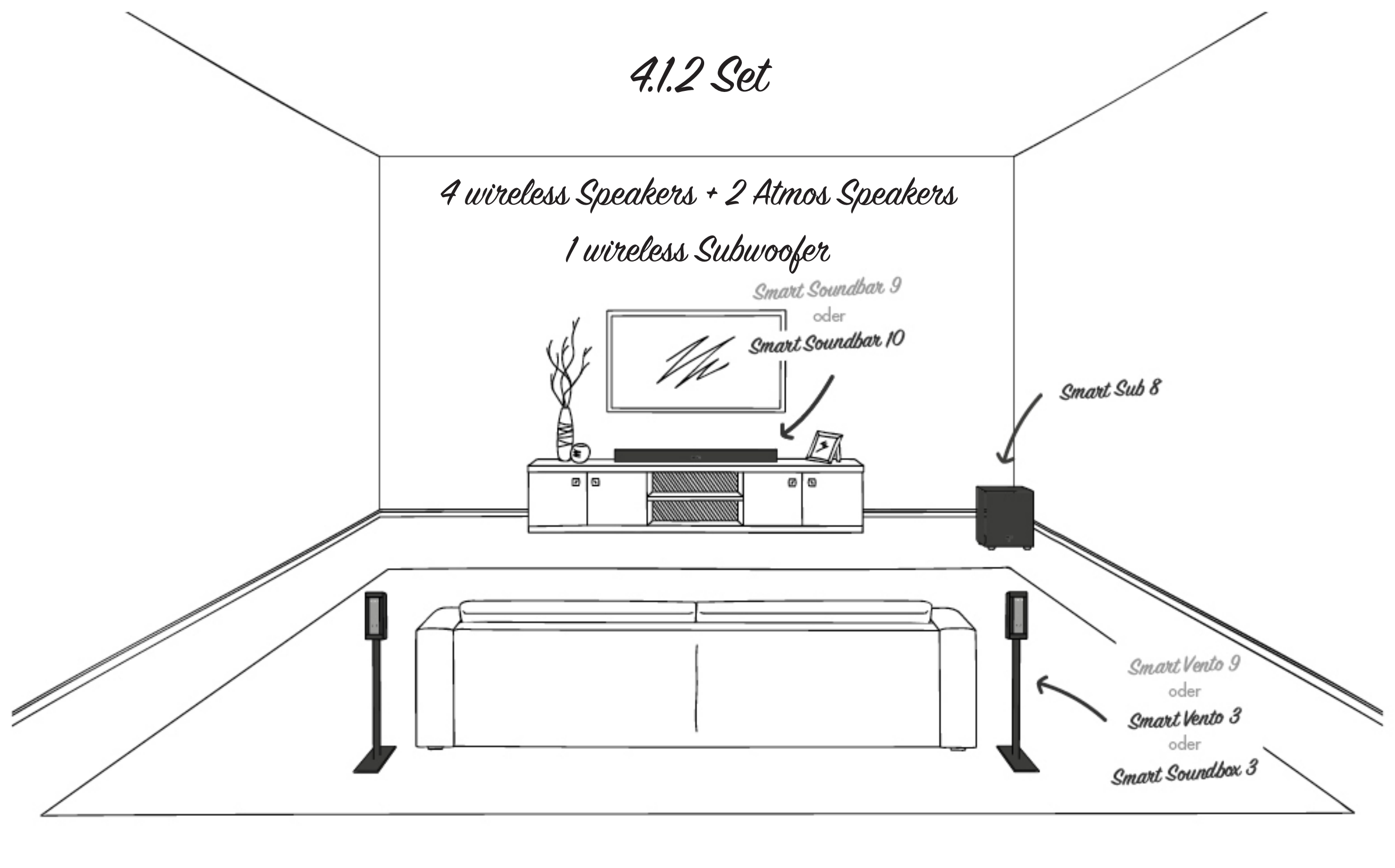

4.1.4 Set

4 wireless Speakers + 1 wireless Subwoofer

4 wireless Atmos Speakers

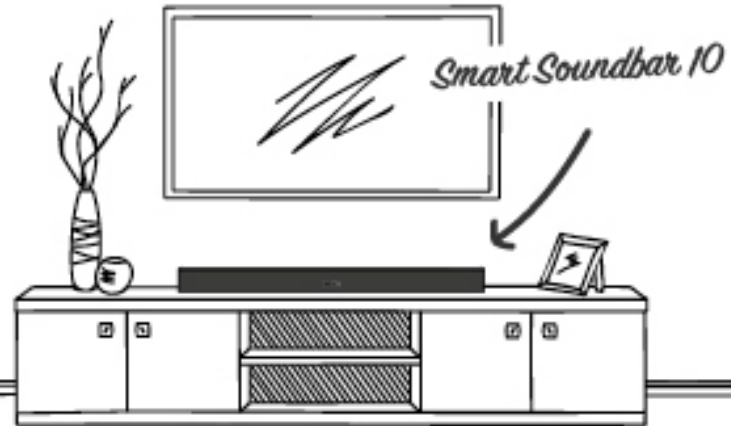

Smart Soundbox 3

Smart Sub 8

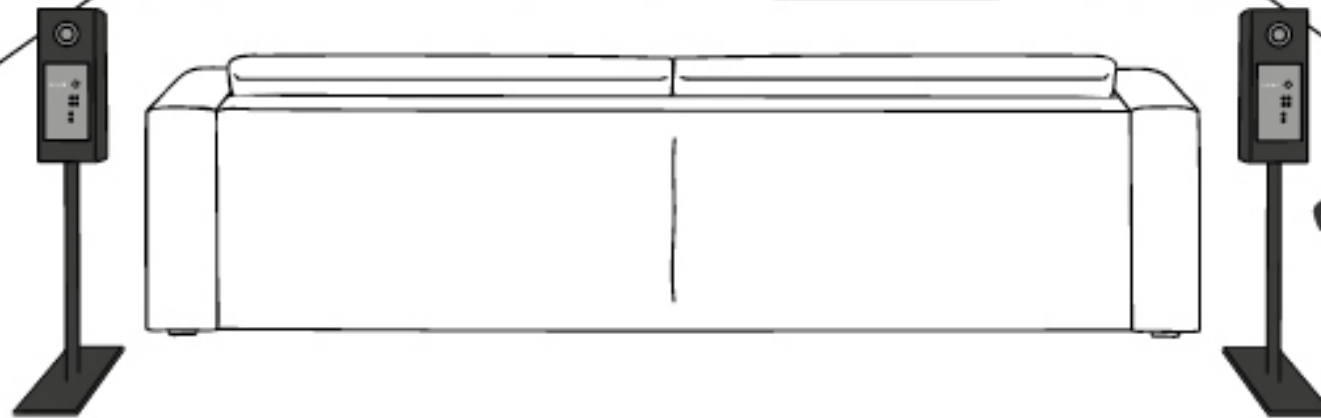

Smart Vento 9
oder
Smart Vento 3
oder
Smart Soundbox 3

4.1 Set

4 wireless Speakers
1 wireless Subwoofer

Smart Vento 9
oder
Smart Vento 3
oder
Smart Soundbox 3

Smart Sub 8

Smart Vento 9
oder
Smart Vento 3
oder
Smart Soundbox 3

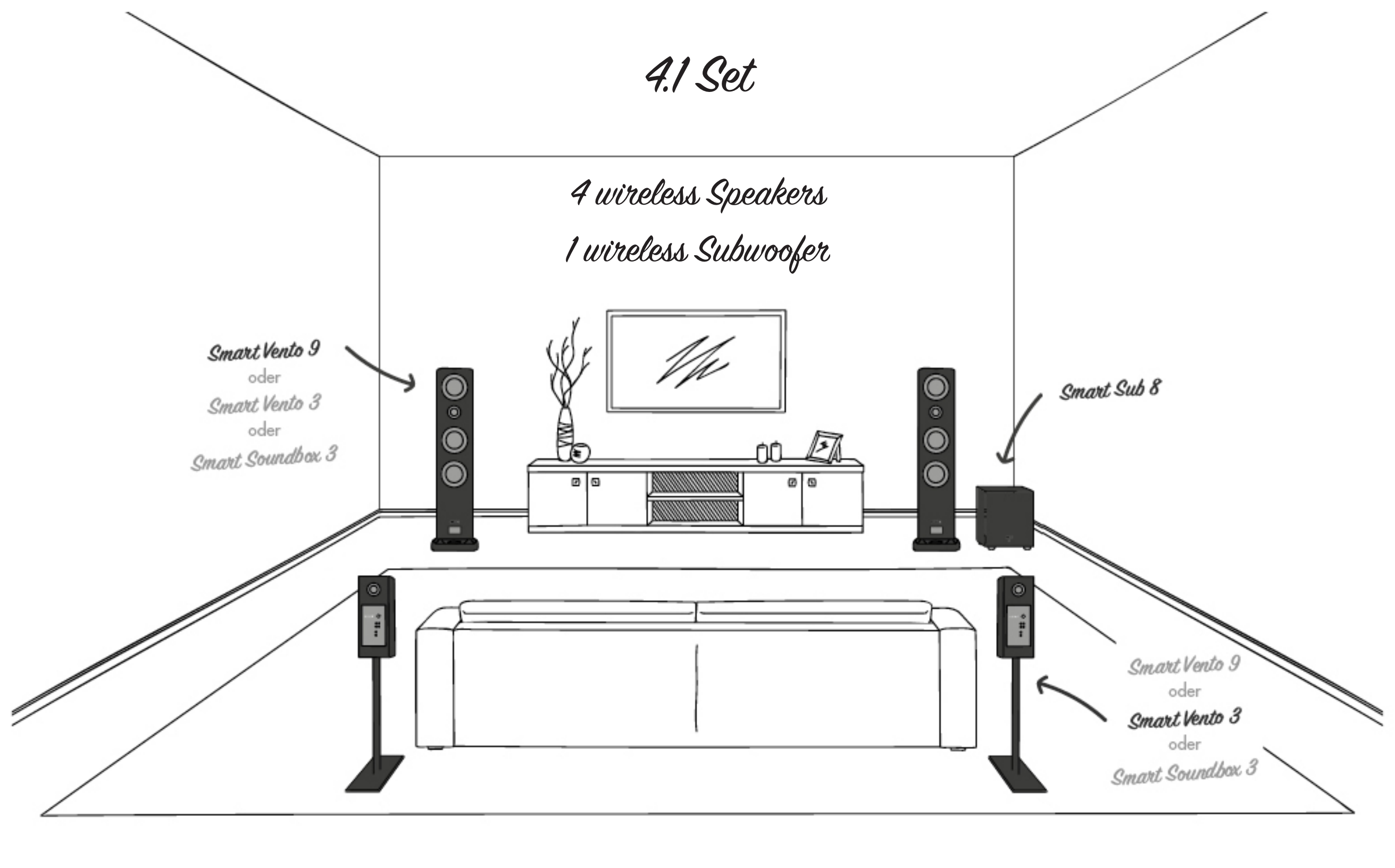

5.1.2 Set

5 wireless Speakers + 2 Atmos Speakers

Smart Vento 9
oder
Smart Vento 3
oder
Smart Soundbox 3

Smart Soundbar 10

Smart Vento 9
oder
Smart Vento 3
oder
Smart Soundbox 3

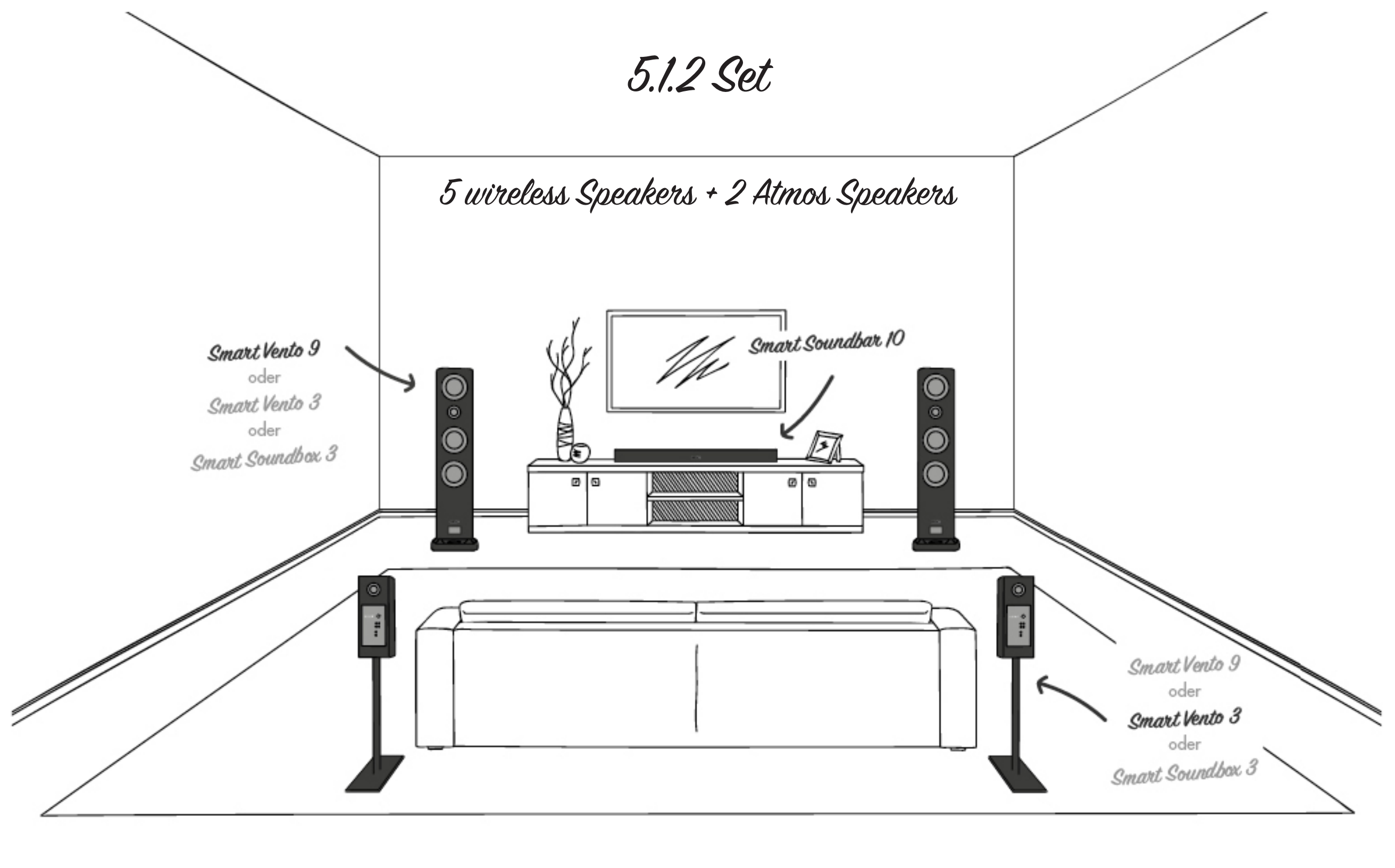

5.1.2 Set

5 wireless Speakers + 2 Atmos Speakers
1 wireless Subwoofer

Smart Vento 9
oder
Smart Vento 3
oder
Smart Soundbox 3

Smart Soundbar 10

Smart Sub 8

Smart Vento 9
oder
Smart Vento 3
oder
Smart Soundbox 3

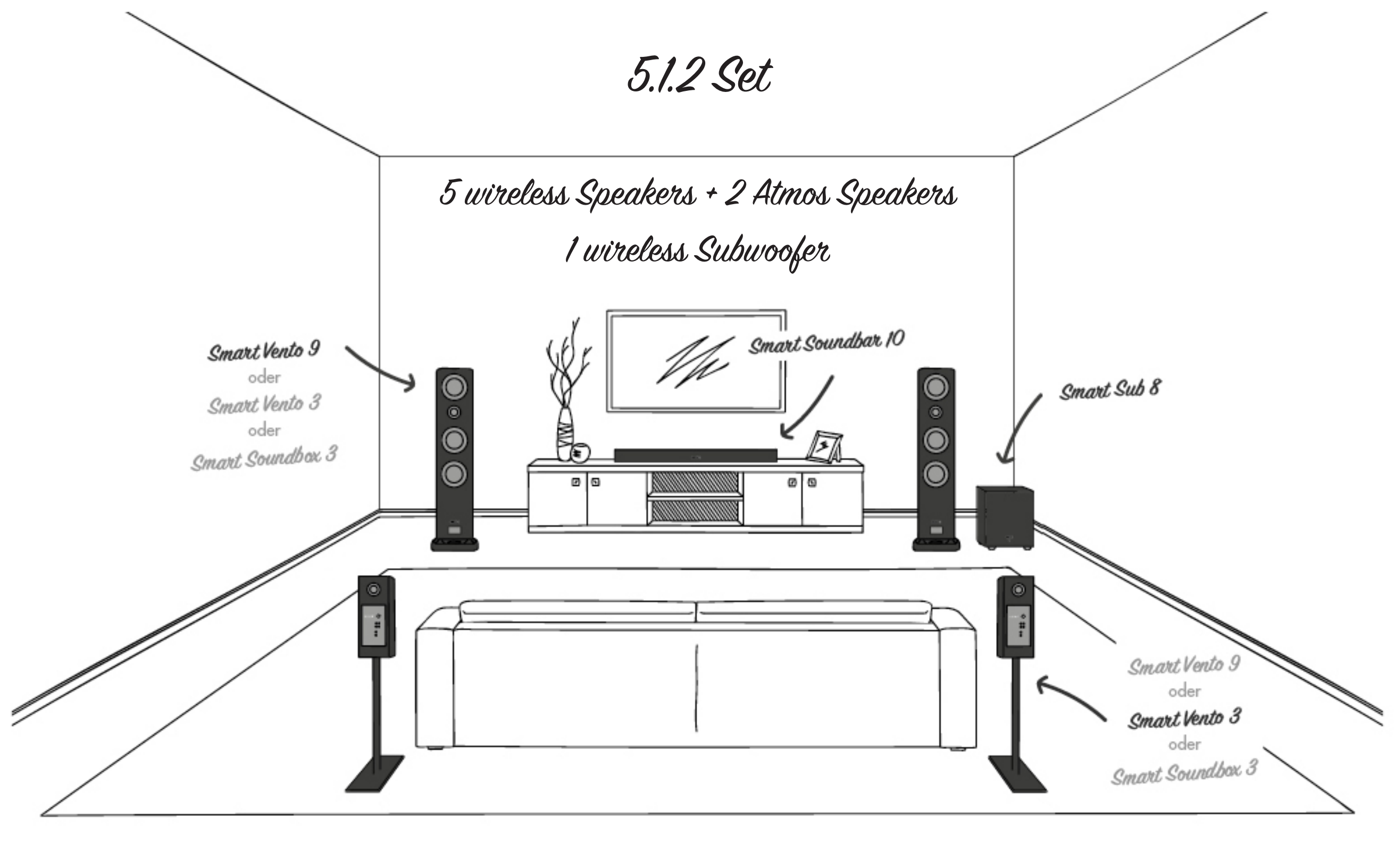

5.1.4 Set

5 wireless Speakers + 1 wireless Subwoofer
4 wireless Atmos Speakers

Smart Vento 9
oder
Smart Vento 3
oder
Smart Soundbox 3

Smart Soundbox 3

Smart Soundbar 10

Smart Sub 8

Smart Vento 9
oder
Smart Vento 3
oder
Smart Soundbox 3

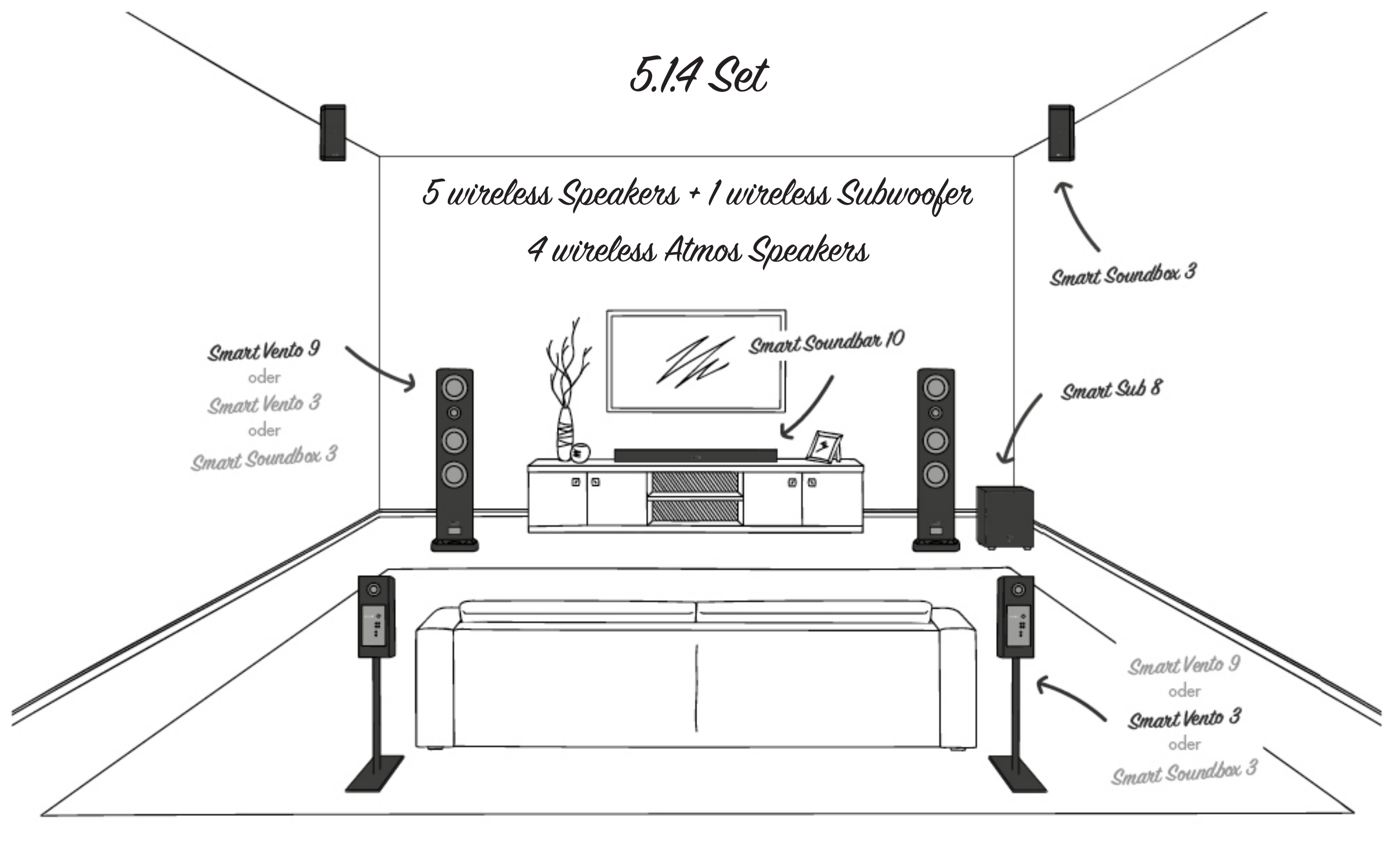

5.1 Set

5 wired Speakers
1 wired Subwoofer

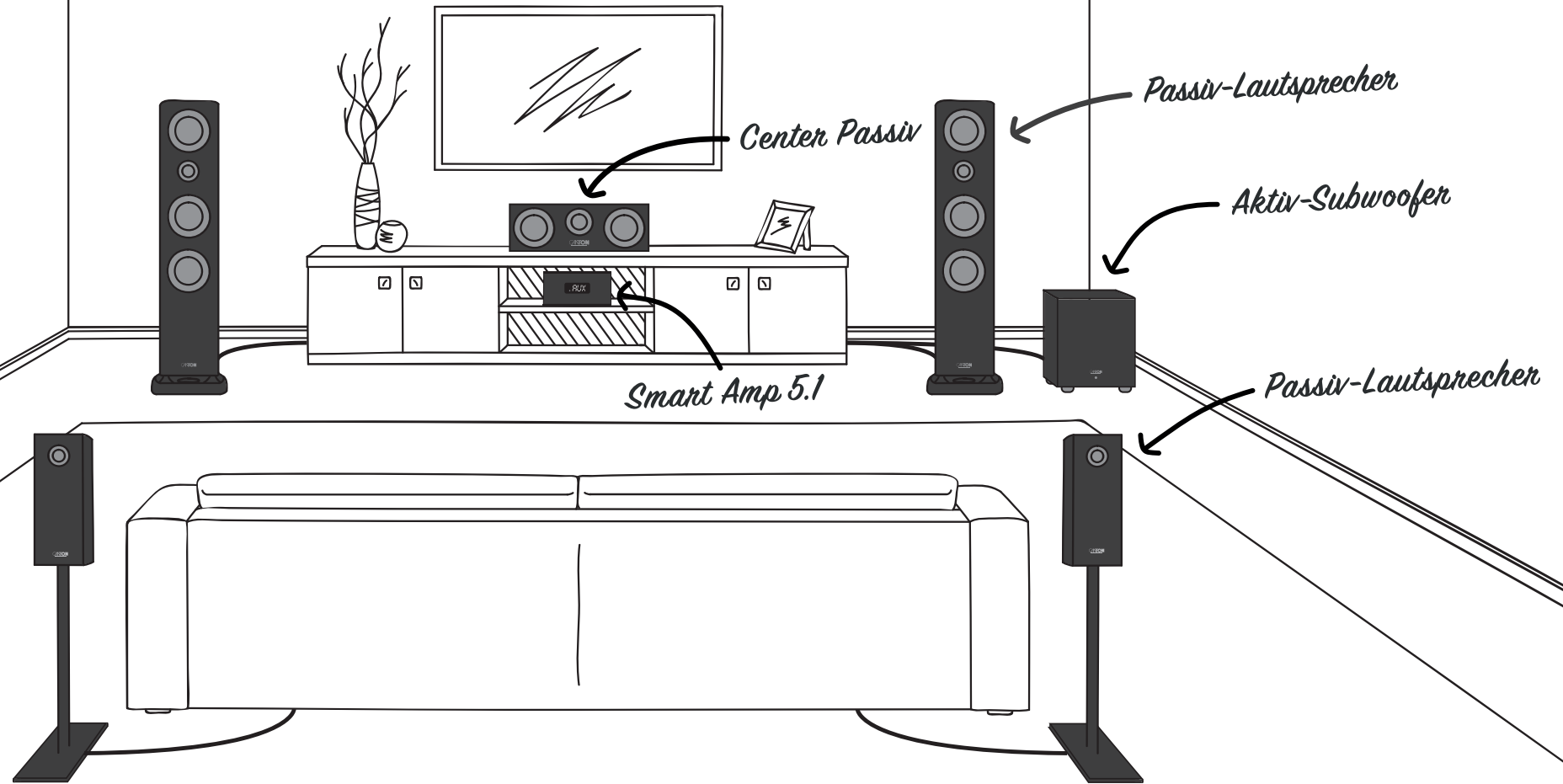

2.0 Set

2 wired Speakers

Passiv-Lautsprecher

Smart Amp 5.1

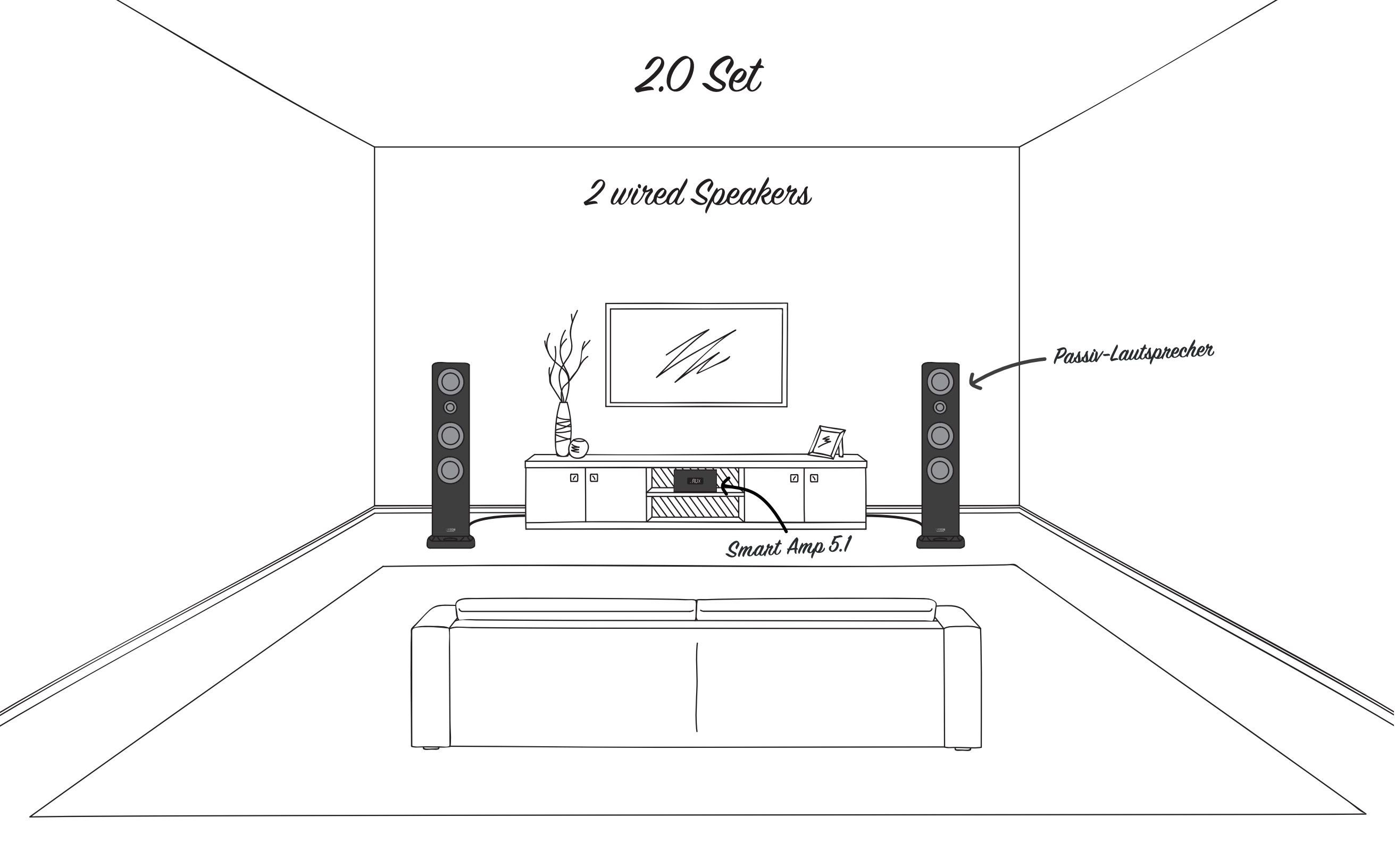

3.1 Set

2 wired Speakers
1 wired Subwoofer

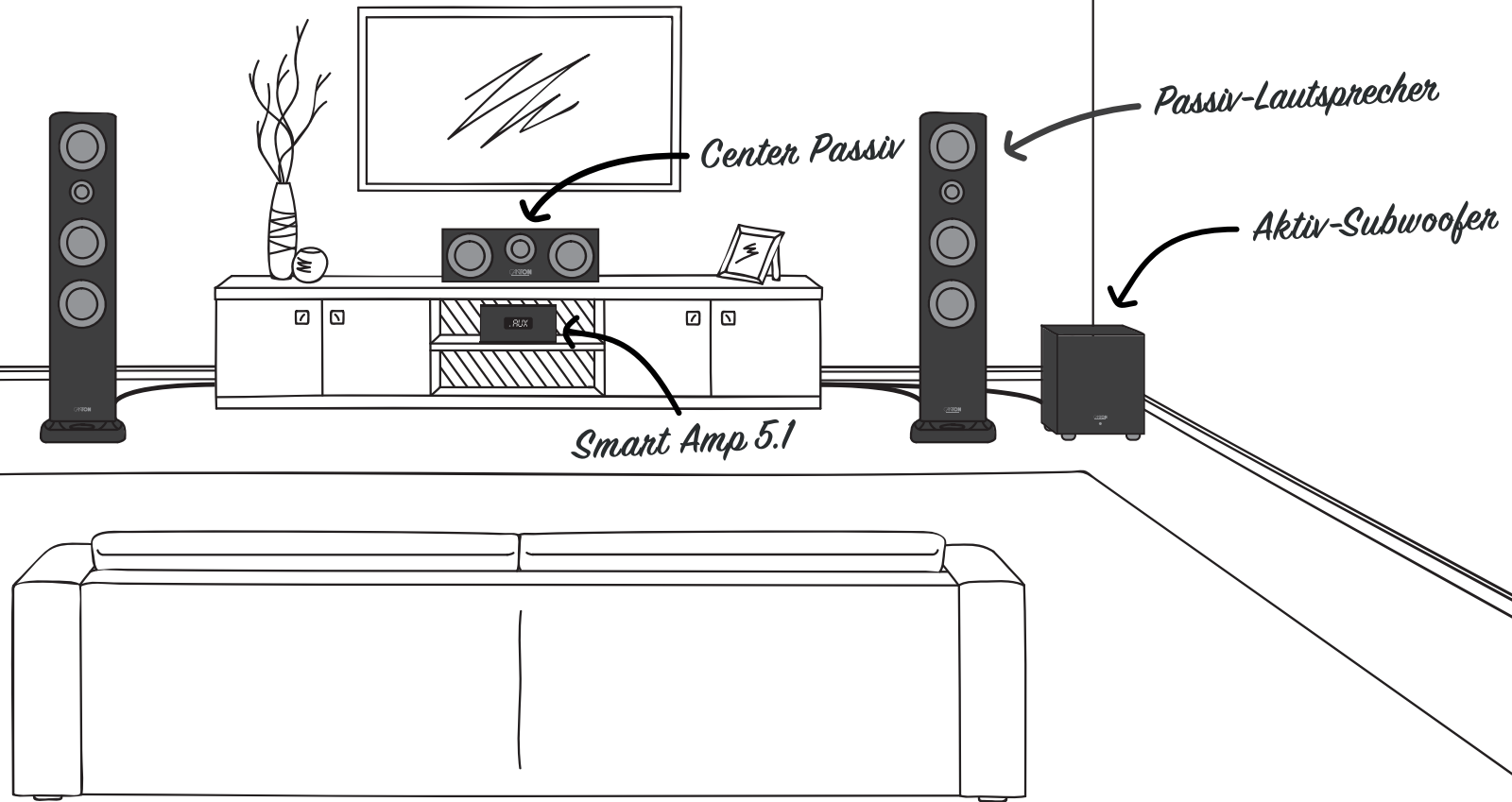

5.1.2 Set

3 wired Speakers + 2 wired Atmos Speakers

1 wireless Subwoofer + 2 wireless Speakers

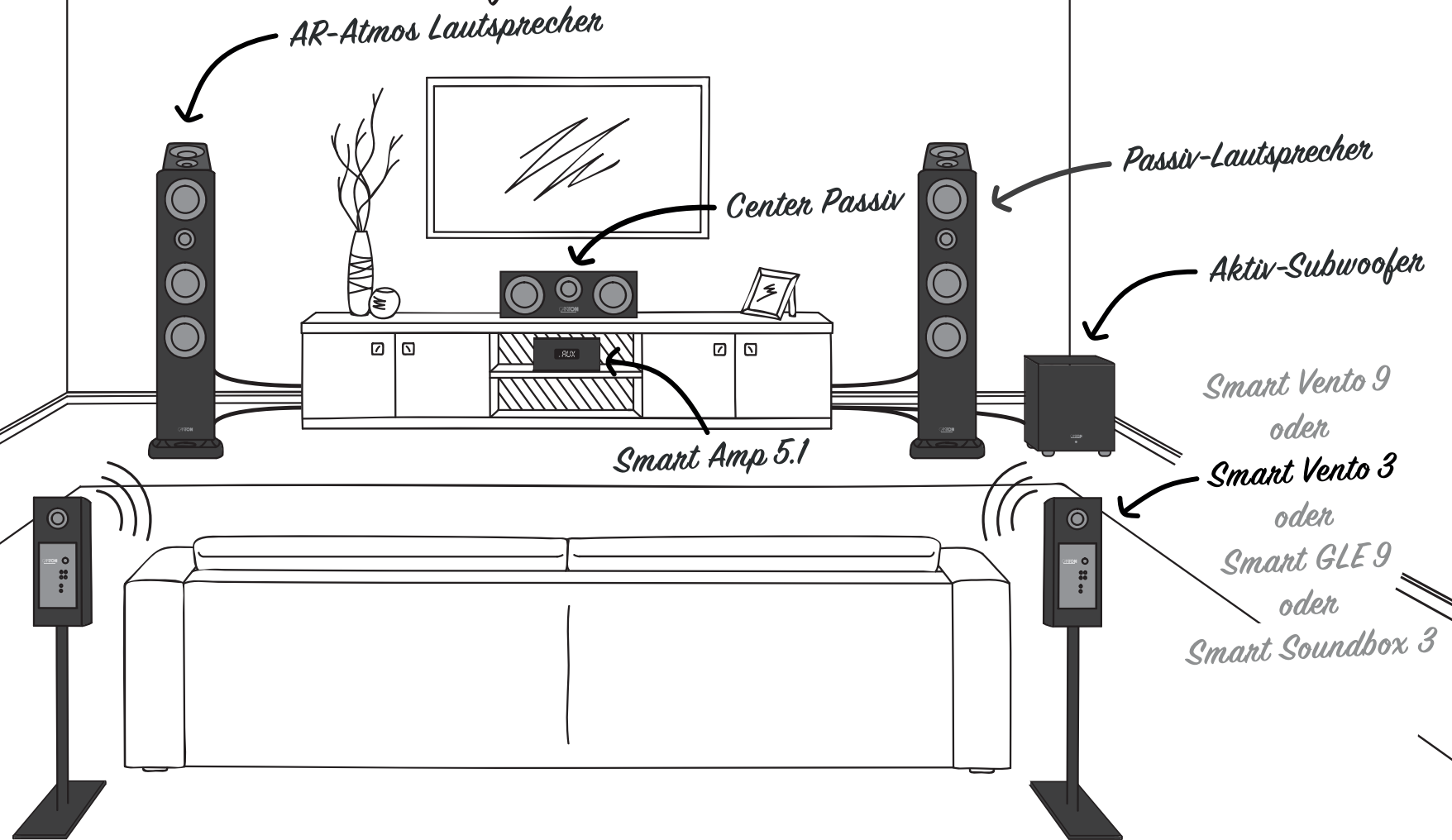

5.1.2 Set

3 wired Speakers + 2 wired Atmos Speakers
1 wireless Subwoofer + 2 wireless Speakers

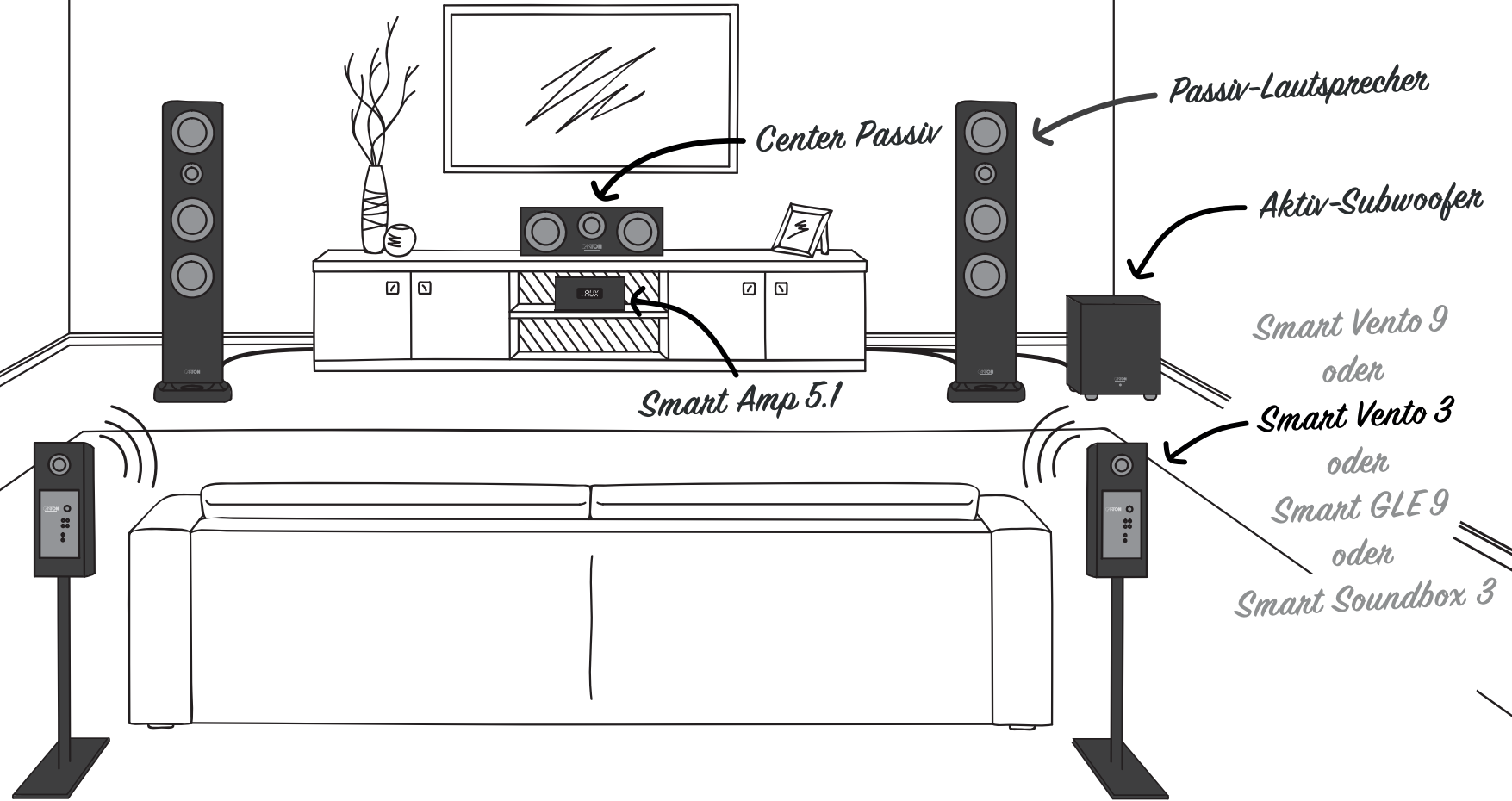

5.1 Set

3 wired Speakers + 1 wired Subwoofer

2 wireless Speakers

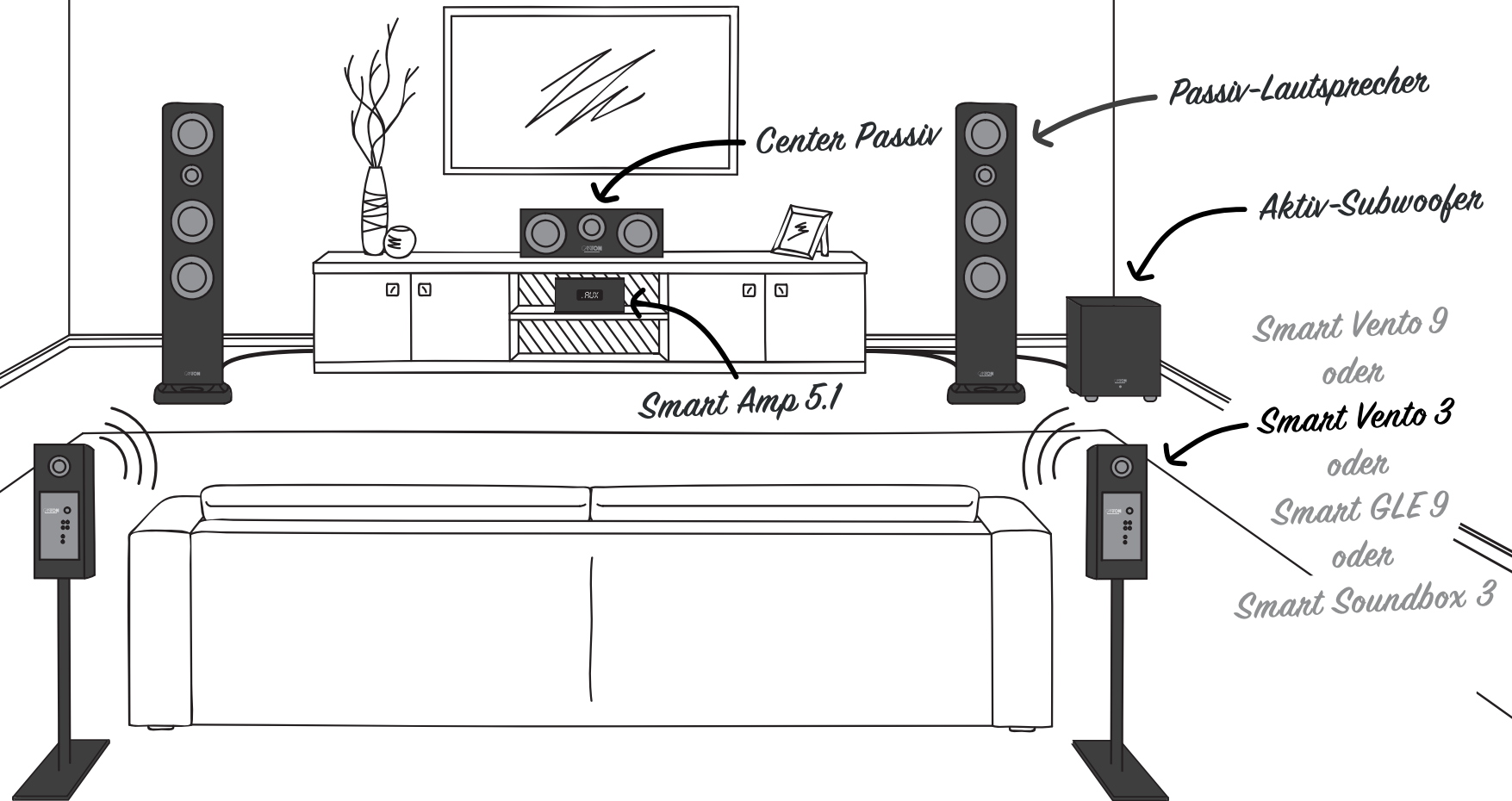

2.0 Set

2 wireless Speakers

Smart Vento 9
oder
Smart Vento 3
oder
Smart GLE 9
oder
Smart Soundbox 3

Smart Connect 5.1

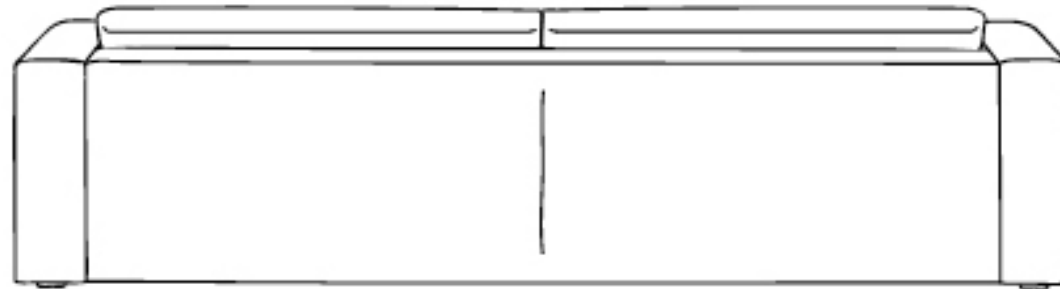

2.0 Set

2 wired Speakers

1 wired Amplifier + Smart Connect 5.1

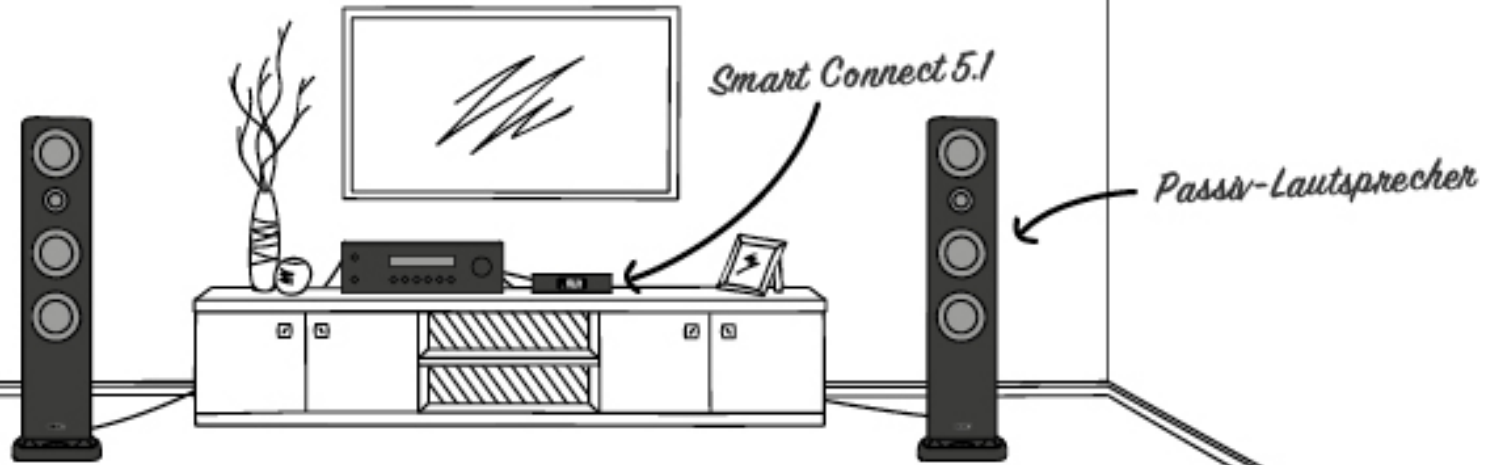

2.1 Set

2 wireless Speakers

1 wireless Subwoofer

Smart Soundbar 9
oder
Smart Soundbar 10

Smart Vento 9
oder
Smart Vento 3
oder
Smart GLE 9
oder
Smart Soundbox 3

Smart Connect 5.1

Smart Sub 8

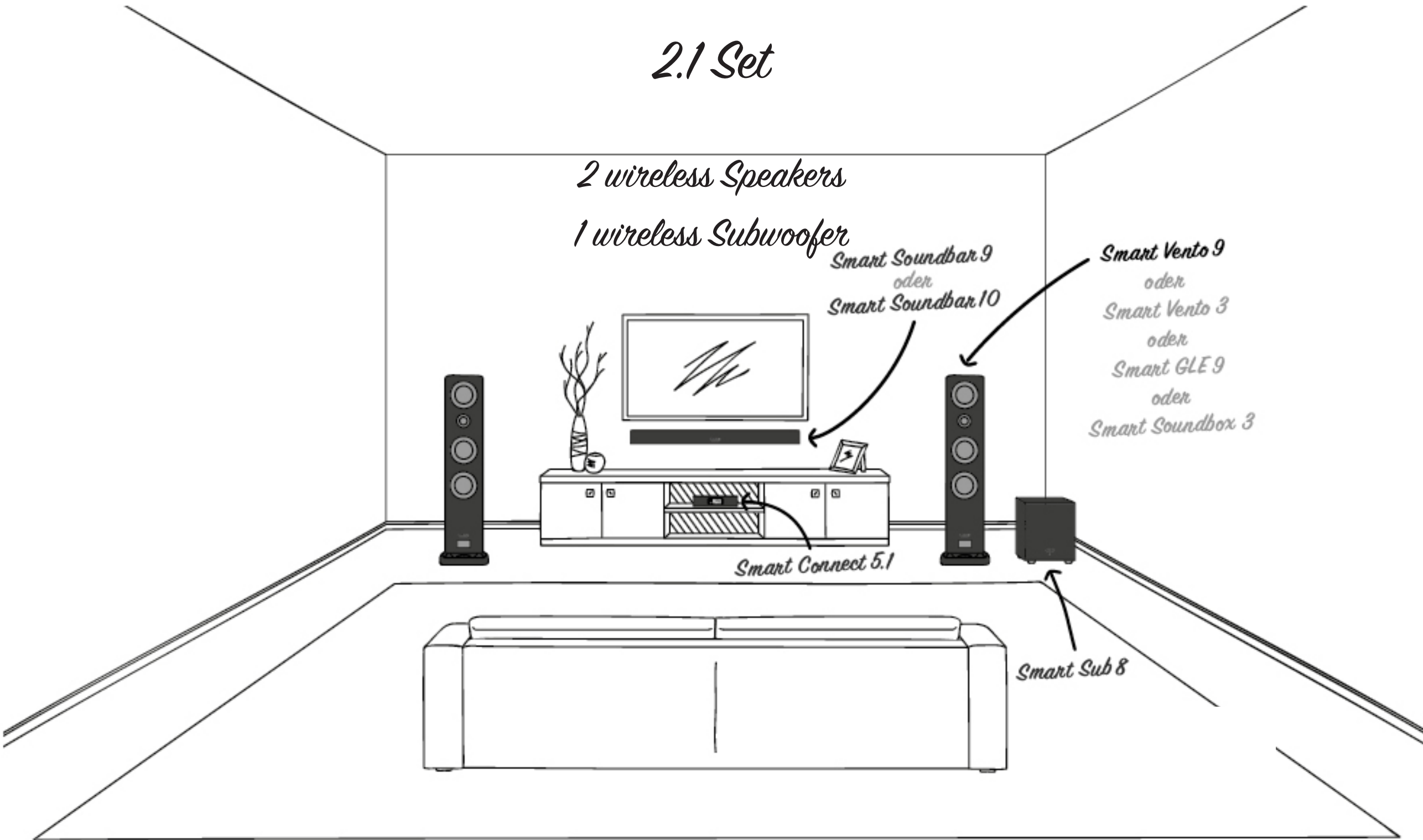

3.1 Set

3 wireless Speakers

1 wireless Sub

Smart Soundbar 9
oder
Smart Soundbar 10

Smart Vento 9
oder
Smart Vento 3
oder
Smart GLE 9
oder
Smart Soundbox 3

Smart Connect 5.1

Smart Sub 8

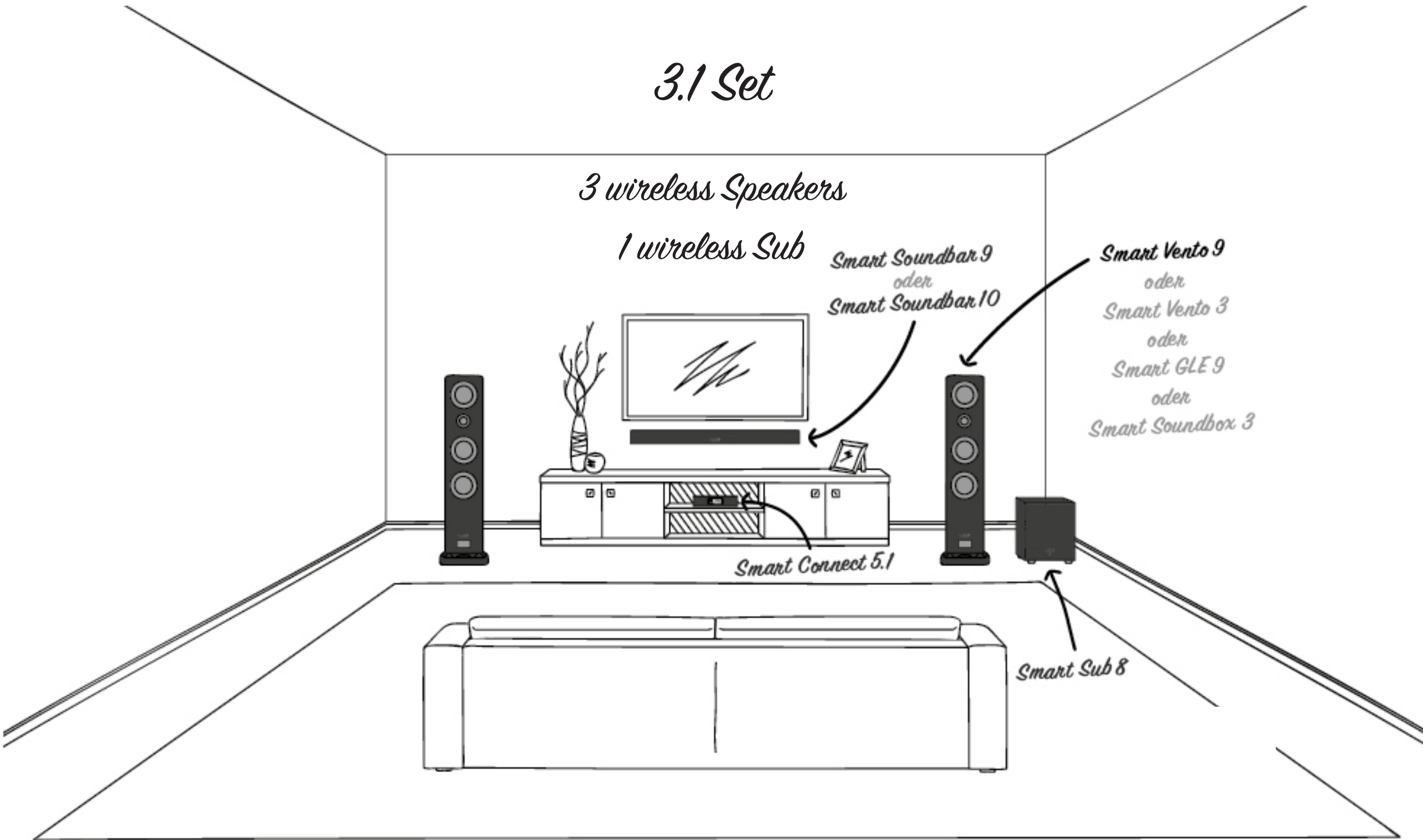

5.1 Set

5 wireless Speakers

1 wireless Sub

Smart Soundbar 9
oder
Smart Soundbar 10

Smart Vento 9
oder
Smart Vento 3
oder
Smart GLE 9
oder
Smart Soundbox 3

Smart Sub 8

Smart Connect 5.1

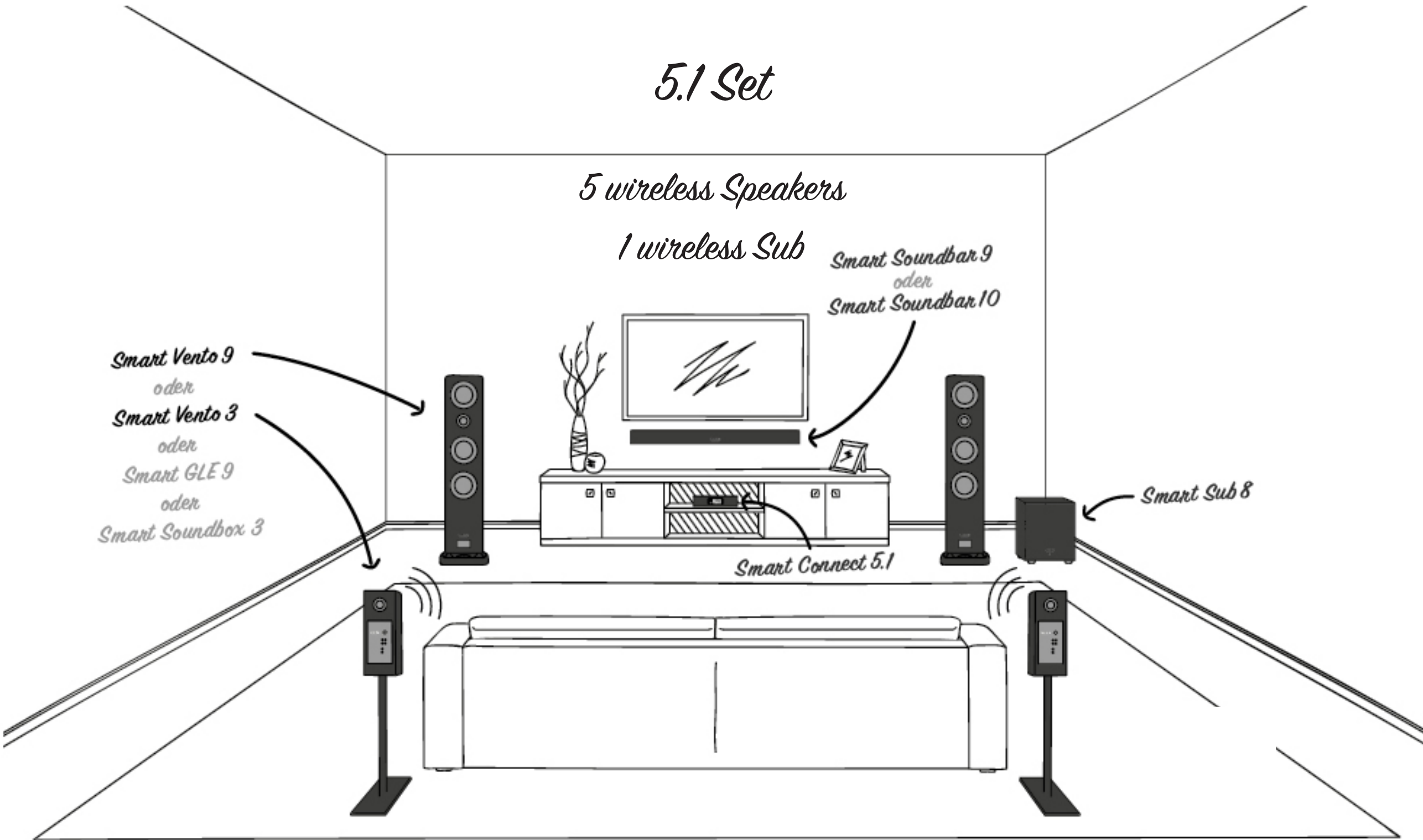

6.2.4 Set

6 wireless Speakers + 4 wireless Atmos Speakers

2 wireless Subs

Smart Soundbar 9
oder
Smart Soundbar 10

Smart Soundbox 3

Smart Vento 9
oder
Smart Vento 3
oder
Smart GLE 9
oder
Smart Soundbox 3

Smart Sub 8

Smart Connect 5.1

