



marantz®

CD Receiver **M-CR611**

You can print more than one page of a PDF onto a single sheet of paper.

Owner's Manual

[Front/Top panel](#)[Rear panel](#)[Remote control unit](#)[Index](#)

Accessories	6
Inserting the batteries	7
Operating range of the remote control unit	7
Features	8
Multiple music formats are supported, all in a compact form factor	8
Easy operation	8
Part names and functions	9
Front/Top panel	9
Rear panel	12
Remote control unit	14

Connections

Speaker connection	18
Connecting the speaker cables	18
Connecting the subwoofer	19
Speaker A connection (Standard)	19
About the speaker B connections	20
About the Bi-Amp connection	21
Connecting a digital device	22
Connecting an analog device	23
Connecting an amplifier	24
Connecting an iPod or USB memory device to the USB port	25
Connecting a DAB/FM antenna	27
Connecting to a home network (LAN)	28
Wired LAN	28
Wireless LAN	29
Connecting the power cord	31



Playback

Basic operation	33
Turning the power on	33
Selecting the input source	33
Adjusting the volume	34
Turning off the sound temporarily	34
Playing CDs	35
Playing CDs	35
Playing tracks in a specific order (Program playback)	36
Playing DATA CDs	37
Playing files	38
Listening to Internet Radio	39
Listening to Internet Radio	40
Playing the last played Internet Radio station	41
Using vTuner to add Internet Radio stations to favorites	42
Playing back files stored on a PC and NAS	43
Applying media sharing settings	44
Playing back files stored on a PC and NAS	45

Listening to DAB/FM broadcasts	47
Listening to DAB/FM broadcasts	47
Changing the FM tuning mode (Tune Mode)	48
Automatically presetting FM stations (Auto Preset)	48
RDS Search	49
PTY Search	49
TP Search	50
Radio Text	51
Listening to DAB	51
Favorite function	53
Registering stations or files to the favorites list	54
Calling stations or files from the favorites list	54
To switch between registered stations and files during playback	54
Deleting stations or files from the favorite list	54
Playing an iPod	55
Listening to music on an iPod	56
Setting operation mode ("On-Display" mode)	57
Charging the iPod/iPhone	58
Playing a USB memory device	59
Playing files stored on USB memory devices	60



Listening to music on a Bluetooth device	61
Playing music from Bluetooth device	62
Pairing with other Bluetooth devices	64
Reconnecting to this unit from a Bluetooth device	65
Connecting a Bluetooth device with the NFC function via NFC	66
Listening to DIGITAL IN	67
Listening to ANALOG IN	67
AirPlay function	68
Playing songs from your iPhone, iPod touch or iPad	69
Playing iTunes music with this unit	69
Selecting multiple speakers (devices)	70
Spotify Connect function	71
Playing Spotify music with this unit	71
Remote play function	72
Settings required for each device	73
Web control function	75
Controlling the unit from a web control	75
Convenience functions	81
Adjusting the tone	82
Sleep timer function	83
Checking the current time	83
Switching the display's brightness	84
Listening to music in two locations using a multi-drive connection	85

Settings

Menu map	87
Menu operation	91
Inputting characters	92
Using the number buttons	92
Using the cursor buttons	93
General	94
Alarm	94
Clock	95
Clock Mode	95
Volume Limit	96
CD Auto Play	96
Speaker Configuration	96
Illumination	97
Audio Out	98
Language	98
Auto-Standby	98
Usage Data	99
Firmware	99
Reset	101



Network	102
Network Information	102
Network Control	102
Friendly Name	103
Wi-Fi	103
Bluetooth	103
Settings	104
DAB	110
Making the DAB settings	110

Tips

Tips	112
Troubleshooting	114

Appendix

Playing back DATA CDs	127
Playing back USB memory devices	128
Playing back Internet Radio	130
Playing back Bluetooth devices	130
Bluetooth communications	130
Playing back files stored on PC or NAS	131
About Discs	133
Last function memory	135
Explanation of terms	136
Trademark information	141
Specifications	142
Index	148
License	150







Thank you for purchasing this Marantz product.

To ensure proper operation, please read this owner's manual carefully before using the product.

After reading this manual, be sure to keep it for future reference.

Accessories

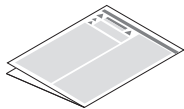
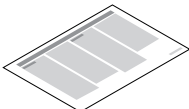
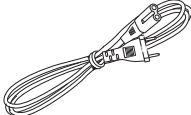
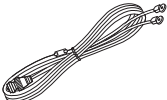
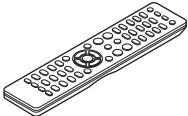
Check that the following parts are supplied with the product.

 Quick Setup Guide	 CD-ROM (Owner's Manual)	 Safety Instructions	 Notes on radio	 Power cord
 FM/DAB indoor antenna	 Remote control unit (RC013CR)	 R03/AAA batteries		



Inserting the batteries

- 1 Remove the rear lid in the direction of the arrow and remove it.

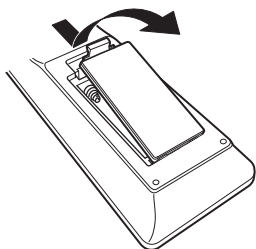

- 2 Insert two batteries correctly into the battery compartment as indicated.

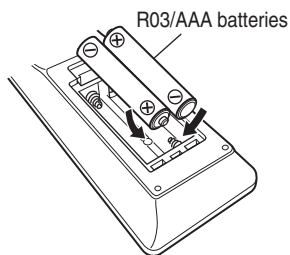

- 3 Put the rear cover back on.

NOTE

- To prevent damage or leakage of battery fluid:
 - Do not use a new battery together with an old one.
 - Do not use two different types of batteries.
- If the battery fluid should leak, carefully wipe the fluid off the inside of the battery compartment and insert new batteries.

Operating range of the remote control unit

Point the remote control unit at the remote sensor when operating it.

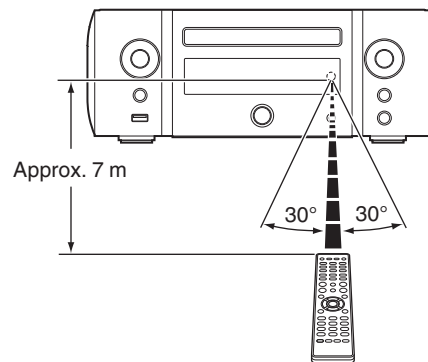

Features

Multiple music formats are supported, all in a compact form factor

- **Supports Internet Radio and music streaming**
Supports AirPlay® (🔊 p. 68)
 You can enjoy a wide variety of content, including listening to Internet Radio, playing audio files stored on your PC.
 This unit also supports Apple AirPlay which lets you stream your music library from an iPhone®, iPad®, iPod touch® or iTunes®.
- **DLNA (Digital Living Network Alliance) ver. 1.5 support for audio networks**
- **Supports Spotify Connect**
- **Support for High Quality Audio playback**
 WAV/FLAC/ALAC (Apple Lossless Audio Codec)/AIFF/DSD (2.8 MHz)
- **Support for Gapless playback**
 Playback with no gap between music files (for WAV/FLAC/ALAC/AIFF/DSD (2.8 MHz) only).
- **Wi-Fi network capability with built-in diversity antenna, and is certified under WMM (Wi-Fi Multi Media) for efficient wireless connectivity**
- **Equipped with high sound quality, high power digital amplifier and connects using the bi-amp method**
- **Can be connected to 2 sets of speakers**
 The volume of each speaker can be adjusted.

Easy operation

- **Easy wireless connection is possible by pressing the Wi-Fi CONNECT button (WPS and Wi-Fi Sharing)**
 See the separate “Quick Setup Guide”.
- **Wireless connection with Bluetooth devices can be carried out easily**
 You can enjoy music simply by connecting wirelessly with your smartphone, tablet, PC, etc.
- **If the Bluetooth device has NFC function, you can connect easily to touch to N mark**
- **iPod auto detect charges your device even after the unit switches to standby mode**
- **“Marantz Hi-Fi Remote” is application software that allows you to perform basic operations with an iPad, iPhone, Android smartphone or Android tablet such as turning the unit ON/OFF, controlling the volume, and switching the source**
 * Download the appropriate “Marantz Hi-Fi Remote” for your iOS or Android devices. This unit needs to be connected to your LAN and the iPad, iPhone, Android smartphone, Android tablet or other device needs to be connected to the same network by Wi-Fi (wireless LAN).
- **OLED (Organic Light Emitting Diode) display that can display 3 lines**
- **Auto Standby mode for energy savings**



Part names and functions

Front/Top panel

[Top panel]



[Front panel]

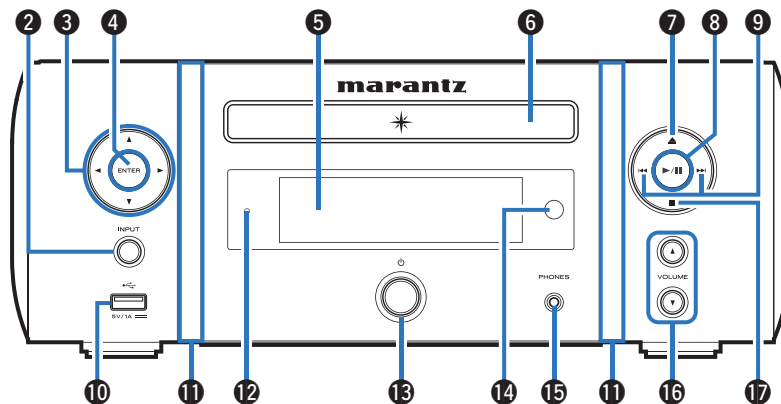

【Top panel】

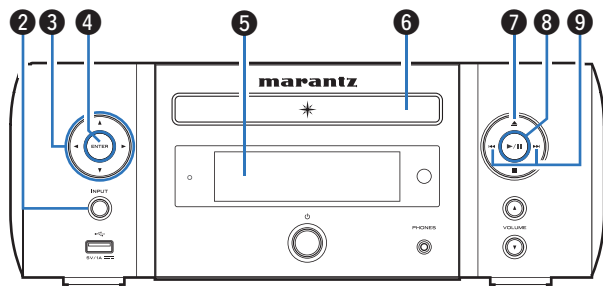

【Front panel】

**1 N mark (N)**

Touch this mark with a Bluetooth device that includes the NFC function when pairing (registering) with it. (☞ p. 66)

2 Input source select button (INPUT)

Selects the input source. (☞ p. 33)

3 Cursor buttons (Δ▽◀▶)

These select items.

4 ENTER button

This determines the selection.

5 Display

Various information is displayed here.

6 Disc tray

Tray used to insert a compact disc. (☞ p. 133)

7 Disc tray open/close button (▲)

Used to open/close the disc tray.

8 Play/pause button (▶/||)**9 Reverse-skip / Forward-skip buttons (◀◀, ▶▶)**

【Front panel】

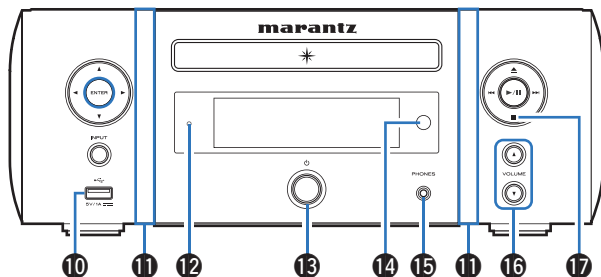
**10 USB port (🔌, Front)**

Used to connect iPod or USB memory devices. (📖 p. 25)

11 Front panel illumination

Lights when the power is on. The illumination color can be changed/turned off using "Illumination" in the menu. (📖 p. 97)

12 Standby indicator

The standby indicator changes as shown below according to the status of the unit.

- Power on : Off
- Normal standby : Off
- iPod charge standby : Red (📖 p. 58)
- Display off : Green (📖 p. 84)
- Alarm standby : Orange (📖 p. 94)
- When "Network Control" is set to "On" : Red (📖 p. 102)

13 Power operation button (🔌)

Turns power to this unit on and off (standby). (📖 p. 33)



- When "Clock Mode" is turned on, this button switches between normal mode and Clock mode. (📖 p. 95)

14 Remote control sensor

This receives signals from the remote control unit. (📖 p. 7)

15 Headphones jack (PHONES)

Used to connect headphones.

When the headphones are plugged into this jack, audio will no longer be output from the speaker terminals, SW OUT connector and AUDIO OUT connectors.

NOTE

- To prevent hearing loss, do not raise the volume level excessively when using headphones.

16 VOLUME up/down buttons (VOLUME ▲▼)

Adjusts the volume. (📖 p. 34)

17 Stop button (■)

Rear panel

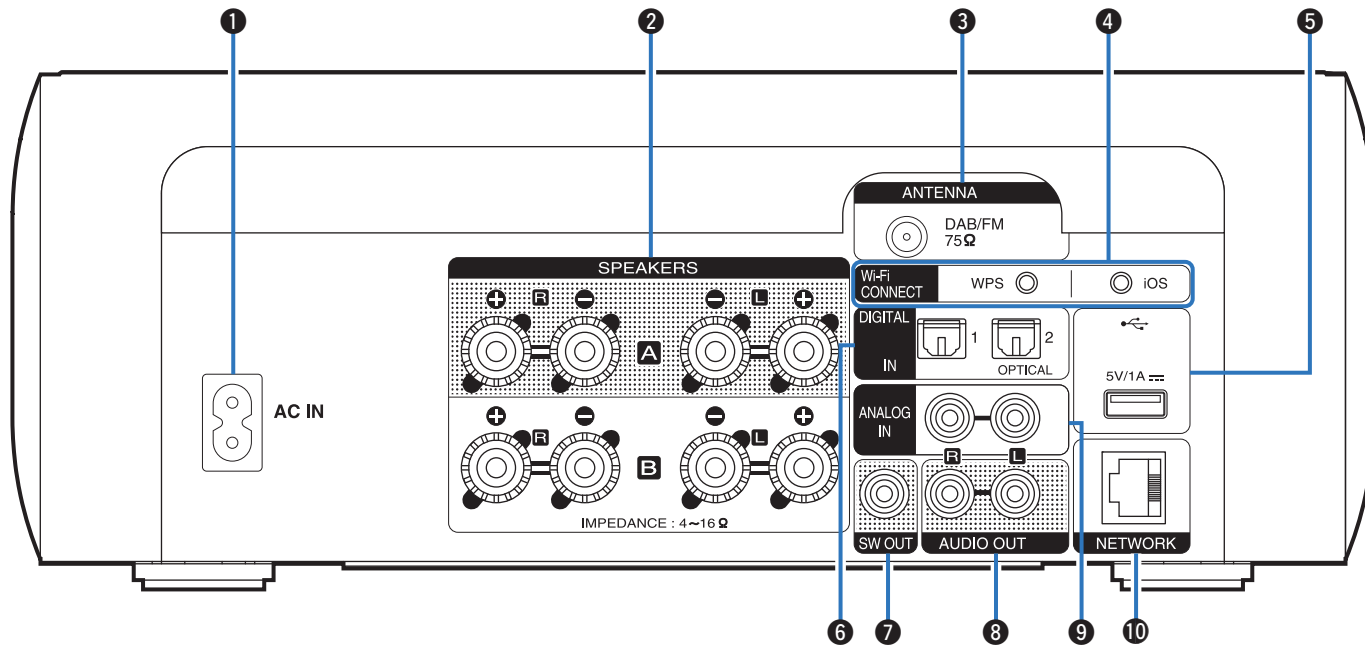

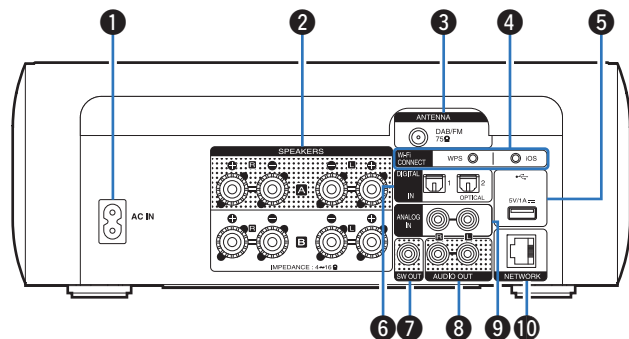

1 AC inlet (AC IN)

Used to connect the supplied power cord. (👉 p. 31)

2 Speaker terminals (SPEAKERS)

Used to connect speakers. (“Speaker connection” (👉 p. 18), “About the Bi-Amp connection” (👉 p. 21))

3 DAB/FM antenna terminal (ANTENNA)

Used to connect DAB/FM antennas. (👉 p. 27)

4 Wi-Fi CONNECT buttons (iOS/WPS)

Used to connect to the wireless LAN.
(See the separate “Quick Setup Guide”.)

5 USB port (👈, Rear)

Used to connect iPod or USB memory devices. (👉 p. 25)

6 DIGITAL IN connectors

Used to connect devices equipped with digital audio connectors.
(👉 p. 22)

7 SW OUT connector

Used to connect a subwoofer with a built-in amplifier. (👉 p. 19)

8 AUDIO OUT connectors

Used to connect devices equipped with analog audio inputs connectors or an external pre-main amplifier. (👉 p. 24)

9 ANALOG IN connectors

Used to connect devices equipped with analog audio connectors.
(👉 p. 23)

10 NETWORK connector

Used to connect this unit to the network. (👉 p. 28)



Remote control unit

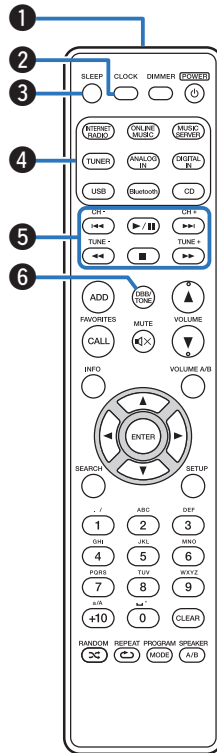

1 Remote control signal transmitter

This transmits signals from the remote control unit. (☞ p. 7)

2 CLOCK button

The current time appear on the unit. (☞ p. 83)

3 SLEEP button

This sets the sleep timer. (☞ p. 83)

4 Input source select buttons

These select the input source. (☞ p. 33)

5 System buttons

These perform playback related operations.

Channel buttons (CH +, -)

These operate the Favorite function. (☞ p. 53)

Tuning buttons (TUNE +, -)

These operate the tuner. (☞ p. 47)

6 DBB/TONE button

Adjusting the tone. (☞ p. 82)



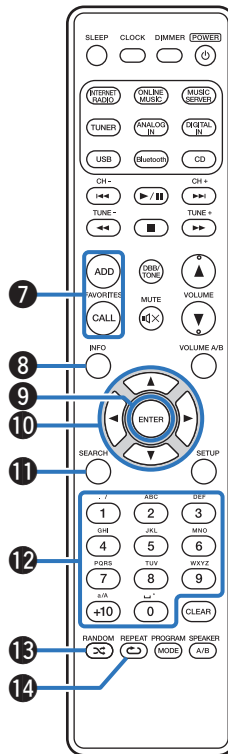

7 FAVORITES ADD / CALL buttons

- To add radio stations or files to the favorite list, press ADD button. (🔗 p. 54)
- To call up a radio station or file registered in the favorite list, press CALL button. (🔗 p. 54)

8 Information button (INFO)

This switches display items such as the artist name and album name in the playback screen.

9 ENTER button

This determines the selection.

10 Cursor buttons (Δ∇◀▶)

These select items.

11 SEARCH button

This displays the search menu.

12 Number buttons (0 – 9, +10)

These enter letters or numbers into the unit.

13 RANDOM button (🎲)

Switches the random playback.

14 REPEAT button (🔄)

Switches to the repeat playback.

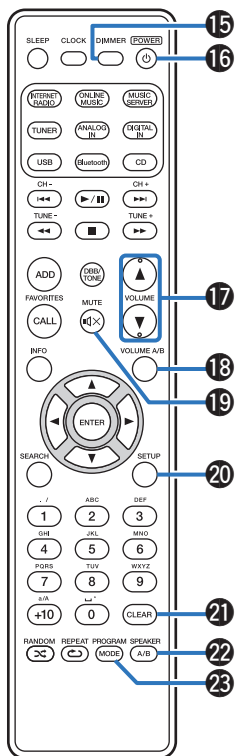

**15 DIMMER button**

Adjust the display brightness of this unit. (☞ p. 84)

16 POWER button (⏻)

This turns the power on/standby. (☞ p. 33)

17 VOLUME buttons (▲▼)

These adjust the volume level. (☞ p. 34)

18 VOLUME A/B button

This specifies which set of speakers (Speaker A/Speaker B) to adjust the volume for when 2 sets of speakers are connected. (☞ p. 86)



- This is only enabled when “Both Speakers A and B = On” is set for the audio output speakers. (☞ p. 86)

19 MUTE button (⏻)

This mutes the output audio. (☞ p. 34)

20 SETUP button

The setting menu is displayed on the display. (☞ p. 91)

21 CLEAR button

This cancels the settings.

22 SPEAKER A/B button

This sets up the speaker output. (☞ p. 86)

23 PROGRAM / MODE button

- Used to connect speakers. (“Changing the FM tuning mode (Tune Mode)” (☞ p. 48), “Setting operation mode (“On-Display” mode)” (☞ p. 57))

• This sets program playback. (☞ p. 36)



■ Contents





Speaker connection	18
Connecting a digital device	22
Connecting an analog device	23
Connecting an amplifier	24
Connecting an iPod or USB memory device to the USB port	25
Connecting a DAB/FM antenna	27
Connecting to a home network (LAN)	28
Connecting the power cord	31

NOTE

- Do not plug in the power cord until all connections have been completed.
- Do not bundle power cords with connection cables. Doing so can result in noise.

■ Cables used for connections

Provide necessary cables according to the devices you want to connect.

Speaker cable	
Subwoofer cable	
Optical cable	
Audio cable	
LAN cable	



Speaker connection

Here we connect the speakers in the room to this unit.

This section explains how to connect them using typical examples.

NOTE

- Disconnect this unit's power plug from the power outlet before connecting the speakers. Also, turn off the subwoofer.
- Connect so that the speaker cable core wires do not protrude from the speaker terminal. The protection circuit may be activated if the core wires touch the rear panel or if the + and - sides touch each other. ("Protection circuit" (ⓘ p. 140))
- Never touch the speaker terminals while the power cord is connected. Doing so could result in electric shock.
- Use speakers with an impedance of 4 – 16 Ω/ohms.

Connecting the speaker cables

Connect the speaker cable to the + speaker terminal (red) and the - speaker terminal (black).

- 1 Peel off about 10 mm of sheathing from the tip of the speaker cable, then twist the core wire tightly.**



- 2 Turn the speaker terminal counterclockwise to loosen it.**



- 3 Insert the speaker cable's core wire to the hilt into the speaker terminal.**

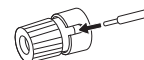

- 4 Turn the speaker terminal clockwise to tighten it.**



Connecting the subwoofer

Use a subwoofer cable to connect the subwoofer.

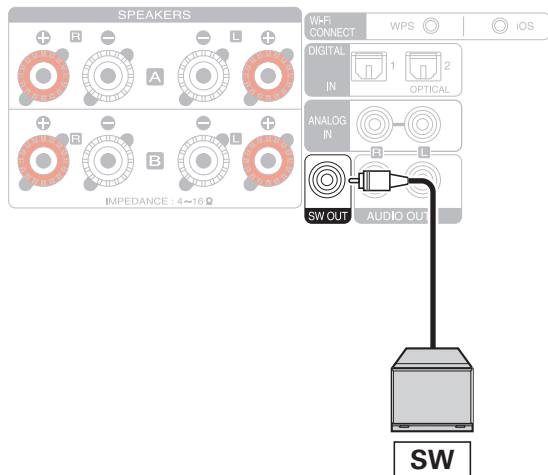

- The subwoofer volume is linked to the Speaker A volume.
- This unit does not output to the subwoofer when "Speaker B = On" is set for the audio output speakers.

Speaker A connection (Standard)

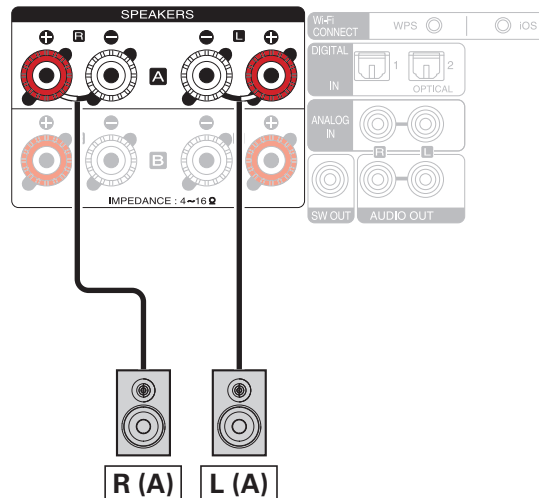

About the speaker B connections

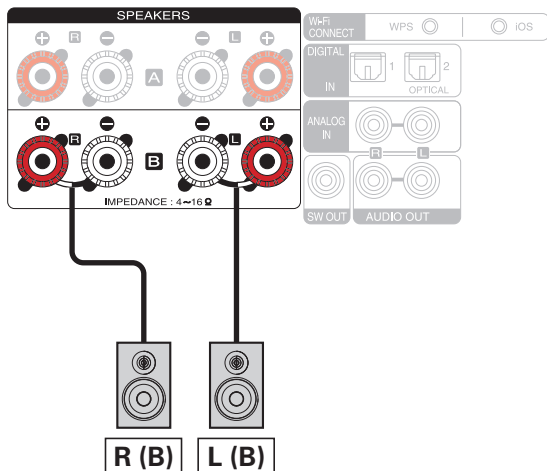

- When using this connection, also set “Bi-Amp” in the menu to “Disable”. (☞ p. 96)
- By connecting speakers to the speaker B terminals as well as the speaker A terminals, the multi-drive connection in which audio can be output from separate speakers or both speakers can be used. (☞ p. 85)



About the Bi-Amp connection

Some audiophile loudspeakers can be connected to an amplifier with two separate amp-to-speaker connections per each speaker. One amplifier channel's output is hooked up to the speaker's bass driver (woofer), while the other amplifier drives the upper range transducers (tweeter, or in some cases midrange and tweeter). This connection method has one amplifier channel driving one half of the bi-amp speaker, and avoids electrical interference between the speaker's bass and treble drivers and the driving amplifier channels. You can assign 4 amp channels to connect to one pair of bi-amp capable speakers. Bi-amp capable speakers always have two sets of speaker input connector pairs, one for the bass range and one for the treble range. If you're unsure about whether or not your speakers are bi-amp capable, consult the owner's manual that came with the speakers.

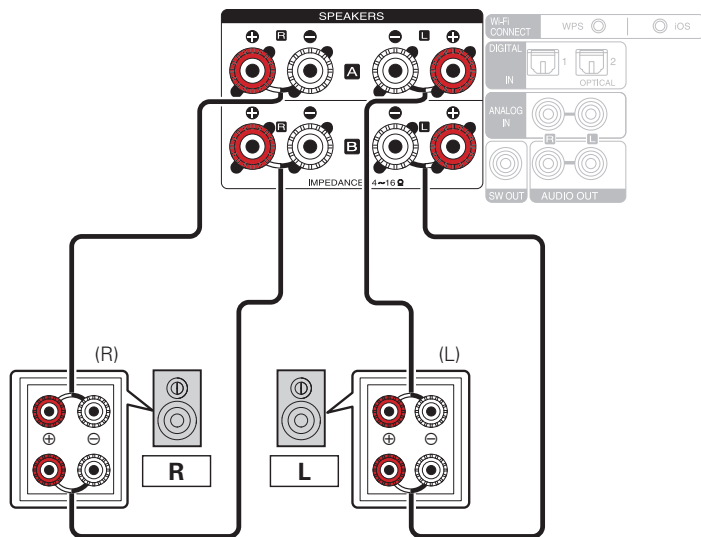

- When using this connection, also set "Bi-Amp" in the menu to "Enable". (p. 96)

NOTE

- When making bi-amp connections, be sure to remove the short-circuiting plate or wire between the speaker's woofer and tweeter terminals.



Connecting a digital device

You can connect this unit to devices with digital audio output (TV, digital gear, etc.).

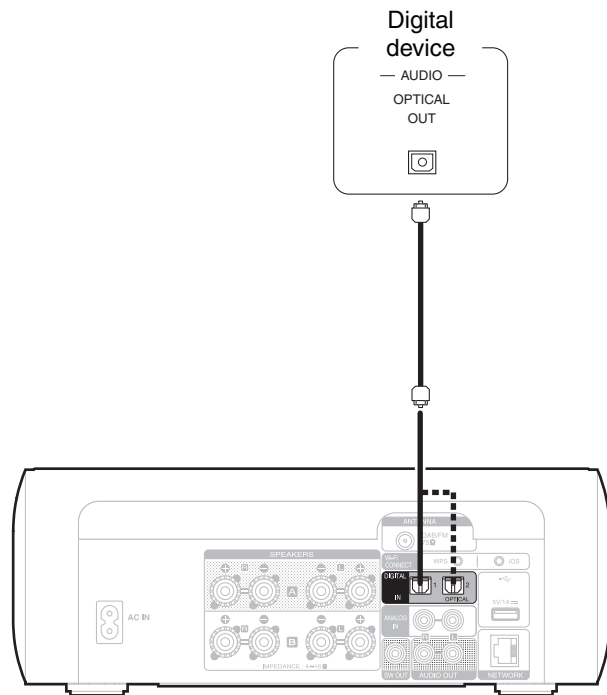

NOTE

- Linear PCM signals with a sampling frequency of 32 kHz, 44.1 kHz, 48 kHz, 88.2 kHz, 96 kHz, 176.4 kHz, or 192 kHz can be input into this device.
- Do not input signals other than linear PCM signals, such as Dolby digital, DTS, AAC etc. into this device. Doing so may cause noise, which may cause damage to the speakers.



Connecting an analog device

You can connect this unit to various devices with analog audio output.

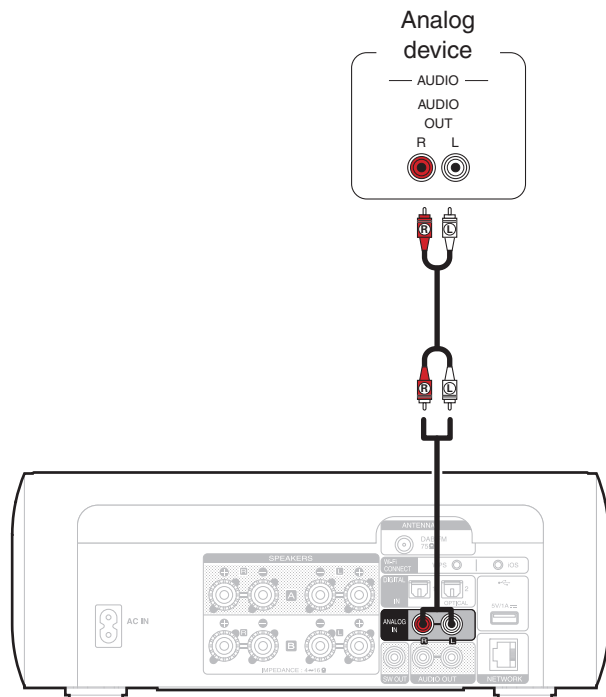

Connecting an amplifier

You can connect this unit to various devices with analog audio input.

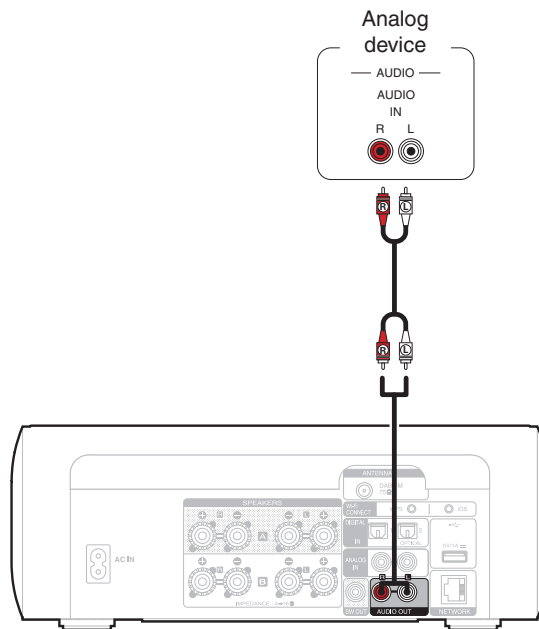

- Volume adjustment for the analog audio output can be switched between "Variable" and "Fixed". (☞ p. 98)
- When the volume adjustment for analog audio output is set to "Variable", the volume is linked to the Speaker A volume. This unit does not output to the analog audio output when "Speaker B = On" is set for the audio output speakers. (☞ p. 86)



Connecting an iPod or USB memory device to the USB port

- To connect an iPod/iPhone to this unit, use the USB adapter cable that was supplied with the iPod/iPhone.
- For operating instructions, see “Playing an iPod” (🔗 p. 55) or “Playing files stored on USB memory devices” (🔗 p. 60).

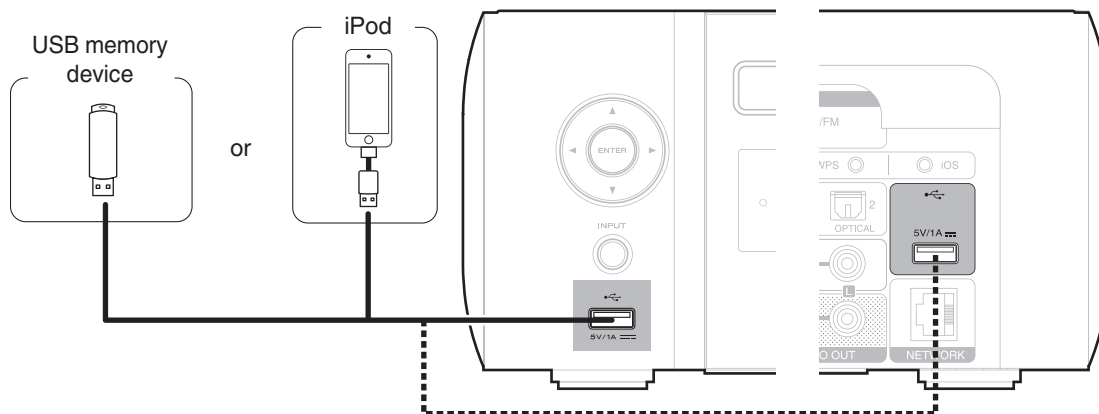

- Marantz does not guarantee that all USB memory devices will operate or receive power. When using a portable USB hard disk drive (HDD) which came with an AC adapter, use that device's supplied AC adapter.

NOTE

- USB memory devices will not work via a USB hub.
- It is not possible to use this unit by connecting the unit's USB port to a PC via a USB cable.
- Do not use an extension cable when connecting a USB memory device. This may cause radio interference with other devices.



■ Supported iPod/iPhone models

• iPod classic



iPod classic
80GB



iPod classic
160GB (2007)



iPod classic
160GB (2009)

• iPod nano



iPod nano
3rd generation
(video)
4GB 8GB



iPod nano
4th generation (video)
8GB 16GB



iPod nano
5th generation (video camera)
8GB 16GB



iPod nano
6th generation
8GB 16GB



iPod nano
7th generation
16GB

• iPod touch



iPod touch
2nd generation
8GB 16GB 32GB



iPod touch
3rd generation
32GB 64GB



iPod touch
4th generation
8GB 16GB 32GB 64GB



iPod touch
5th generation
16GB 32GB 64GB

• iPhone



iPhone 3G
8GB 16GB



iPhone 3GS
16GB 32GB



iPhone 4
8GB 16GB 32GB



iPhone 4S
16GB 32GB 64GB



iPhone 5
iPhone 5c iPhone 5s
16GB 32GB 64GB



Connecting a DAB/FM antenna

After connecting the antenna and receiving a broadcast signal, fix the antenna with tape in a position where the noise level becomes minimal. “Listening to DAB/FM broadcasts” (🔊 p. 47)

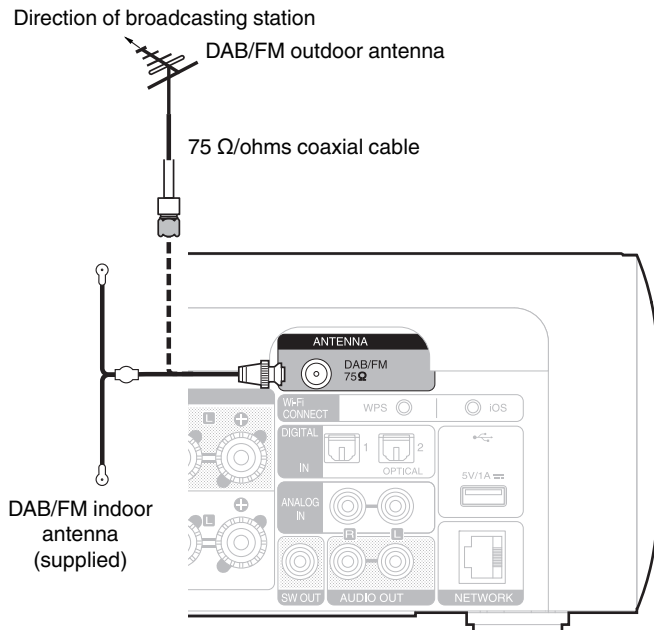

NOTE

- For best results with the supplied indoor antenna, orient the antenna along a wall such that it is stretched out horizontally and parallel to the floor (but above the floor), and then fasten the two end tabs to the wall. This type of antenna is directional and best results will be obtained when it is correctly oriented toward the transmitting location.
- For example, if the transmission tower is to the north, then the two ends of the antenna (with the tabs) should be stretched toward west and east.
- Do not connect two DAB/FM antennas simultaneously.
- If you are unable to receive a good broadcast signal, we recommend installing an outdoor antenna. For details, inquire at the retail store where you purchased the unit.



Connecting to a home network (LAN)

You can connect this unit to your home network (LAN) to perform various types of playbacks and operations as follows.

- Playback of network audio such as Internet Radio and from your music server(s)
- Playback of music content from online streaming services
- Using the Apple AirPlay function
- Operation on this unit via the network
- Firmware Update

For connections to the Internet, contact an ISP (Internet Service Provider) or a computer shop.

Wired LAN

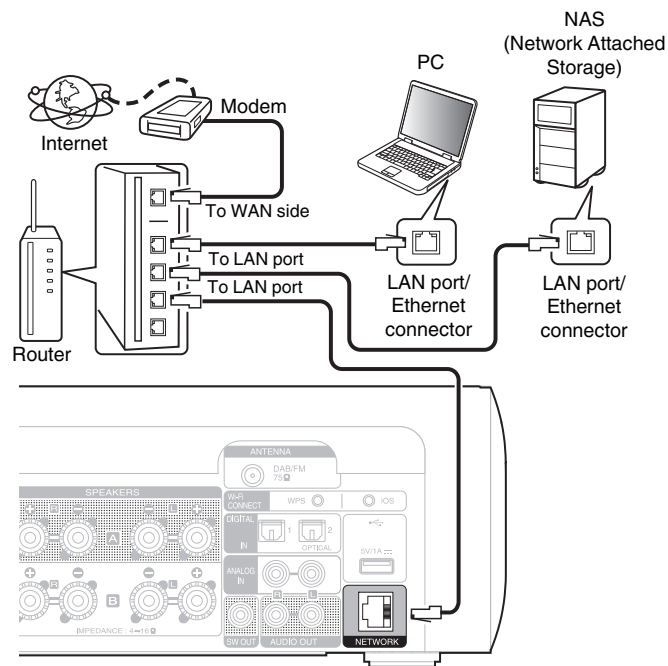

Wireless LAN

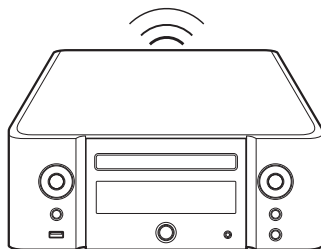
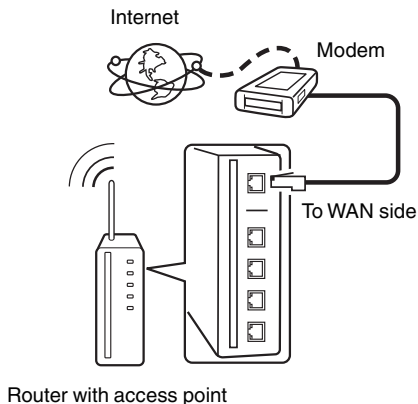

- With this unit, it is possible to use the DHCP and Auto IP functions to make the network settings automatically.
- When using this unit with the broadband router's DHCP function enabled, this unit automatically performs the IP address setting and other settings. When using this unit connected to a network with no DHCP function, make the settings for the IP address, etc., at "Network". (☞ p.102)
- When using this unit, we recommend you use a router equipped with the following functions:
 - Built-in DHCP server
This function automatically assigns IP addresses on the LAN.
 - Built-in 100BASE-TX switch
When connecting multiple devices, we recommend a switching hub with a speed of 100 Mbps or greater.
- Use only a shielded STP or ScTP LAN cable which is easily available at electronics stores. (CAT-5 or greater recommended)
- The normal shielded-type LAN cable is recommended. If a flat-type cable or unshielded-type cable is used, other devices could be affected by noise.
- When using a WPS (Wi-Fi Protected Setup) compatible router, you can connect easily to Wi-Fi by pressing the Wi-Fi CONNECT button (WPS) on this unit. (See the separate "Quick Setup Guide".)



NOTE

- The types of routers that can be used depend on the ISP. Contact your ISP or a computer shop for details.
- This unit is not compatible with PPPoE. A PPPoE-compatible router is required if you have a contract for a type of line set by PPPoE.
- Do not connect a NETWORK connector directly to the LAN port/ Ethernet connector on your computer.



Connecting the power cord

After completing all the connections, insert the power plug into the power outlet.

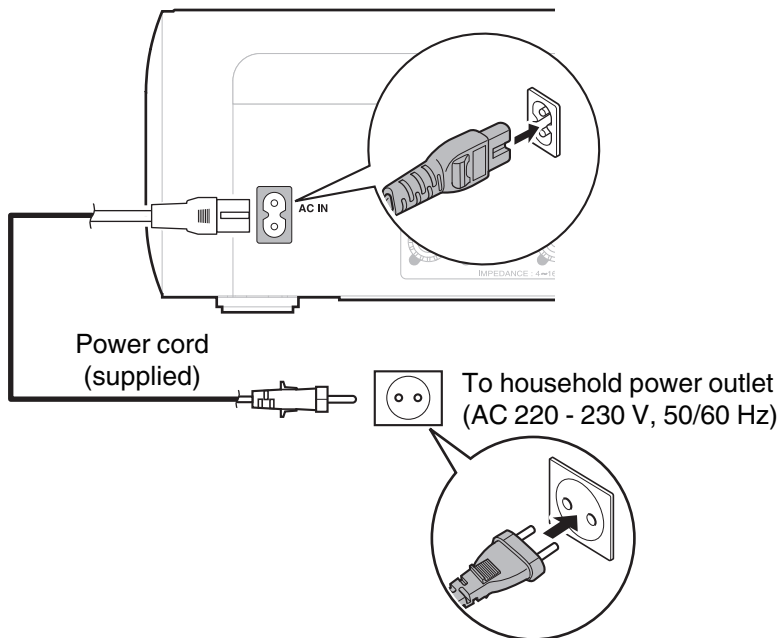

■ Contents

Basic operation

Turning the power on	33
Selecting the input source	33
Adjusting the volume	34
Turning off the sound temporarily	34

Playback a device

Playing CDs	35
Playing DATA CDs	37
Listening to DAB/FM broadcasts	47
Playing an iPod	55
Playing a USB memory device	59
Listening to music on a Bluetooth device	61
Listening to DIGITAL IN	67
Listening to ANALOG IN	67

Playback network audio/service

Listening to Internet Radio	39
Playing back files stored on PC or NAS	43
AirPlay function	68
Spotify Connect function	71

Other functions

Favorite function	53
Remote play function	72
Web control function	75
Convenience functions	81



Basic operation

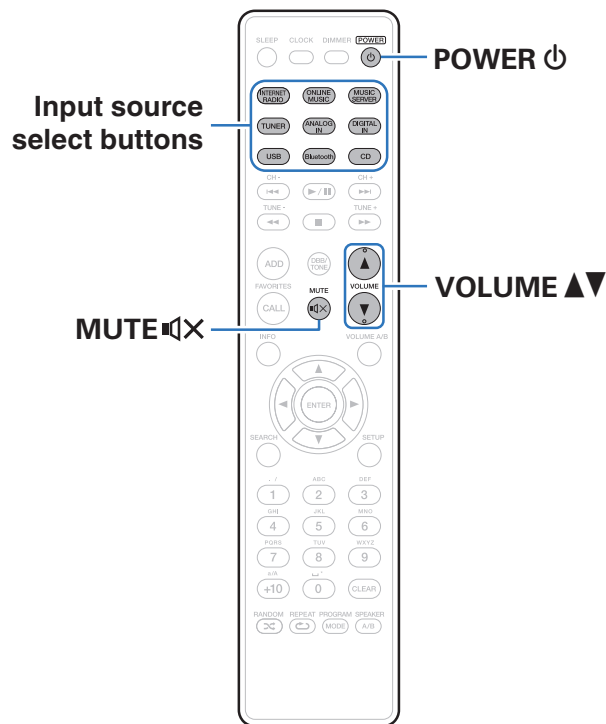

Turning the power on

- 1 Press **POWER** (power icon) to turn on power to the unit.



- You can also switch the power to standby by pressing (power icon) on the main unit.

Selecting the input source

- 1 Press the **input source select button** to be played back. The desired input source can be selected directly.



- Press **TUNER** again to switch between DAB/FM.
- Press **DIGITAL IN** again to switch between Optical In 1/2.
- Press **USB** again to switch between Front USB/Rear USB.
- You can also select the input source by pressing **INPUT** on the main unit.



Adjusting the volume

1 Use **VOLUME ▲▼** to adjust the volume.

The volume level is displayed.



- You can also adjust the volume by turning **VOLUME ▲▼** on the main unit.
- When two sets of speakers are connected and “Both Speakers A and B = On” is set for the audio output speakers, the volume can be adjusted for speakers selected using the Volume A/B button. (🔗 p. 86)

Turning off the sound temporarily

1 Press **MUTE ⏸**.

“MUTING” appears on the display.



- To cancel mute, either adjust the sound volume or press **MUTE ⏸** again.



Playing CDs

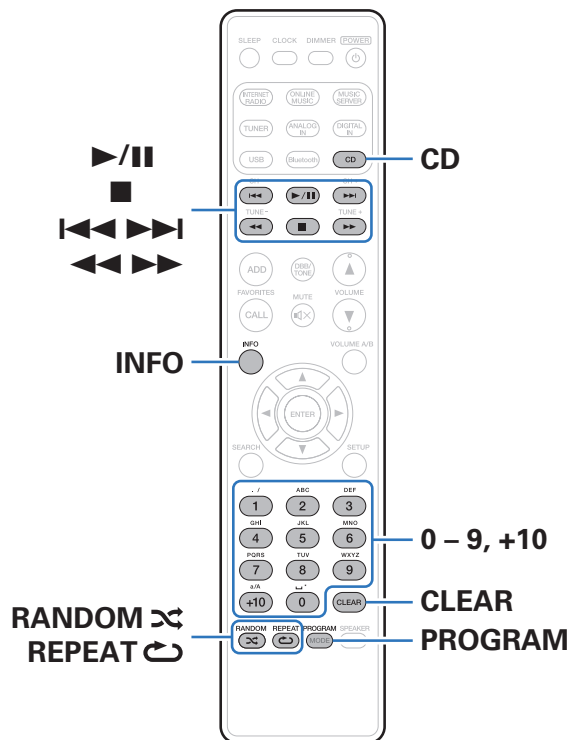

Playing CDs

- 1 Press CD to switch the input source to “CD”.
- 2 Insert a disc. (👉 p. 133)
Playback starts.
 - Press ▲ on the main unit to open/close the disc tray.









- You can set whether to automatically play CDs. (👉 p. 96)

NOTE

- Do not place any foreign objects in the disc tray. Doing so could result in damage.
- Do not push the disc tray in by hand when the power is turned off. Doing so could result in damage.



Operation buttons	Function
	Playback / Pause
	Stop
	Skip to previous track / Skip to next track
	(Press and hold) Fast-reverse / Fast-forward
0 – 9, +10	Select the track
RANDOM 	Random playback <ul style="list-style-type: none"> • Can be set during stop.
REPEAT 	Repeat playback <ul style="list-style-type: none"> • Switching between Single-track repeat and All-track repeat.
INFO	Switching the elapsed time display.

Playing tracks in a specific order (Program playback)

1 In the stop mode, press PROGRAM.

“Program” is displayed.

2 Use 0 – 9, +10 to select the tracks.

[Example]

To program tracks 3, 12, 7 to play in that order: Press PROGRAM, 3, +10, 2, 7.

3 Press .



- The program is cleared when the disc tray is opened or the power is turned off.
- In the stop mode, press CLEAR, the last track programmed is cleared. Press  to select the track you want to delete.
- In the stop mode, press PROGRAM, clear the all programmed track.
- Up to 25 tracks can be programmed.
- When RANDOM is pressed during program playback, the programmed tracks are played in random order.
- When REPEAT is pressed during program playback, the tracks are played repeatedly in the programmed order.



Playing DATA CDs

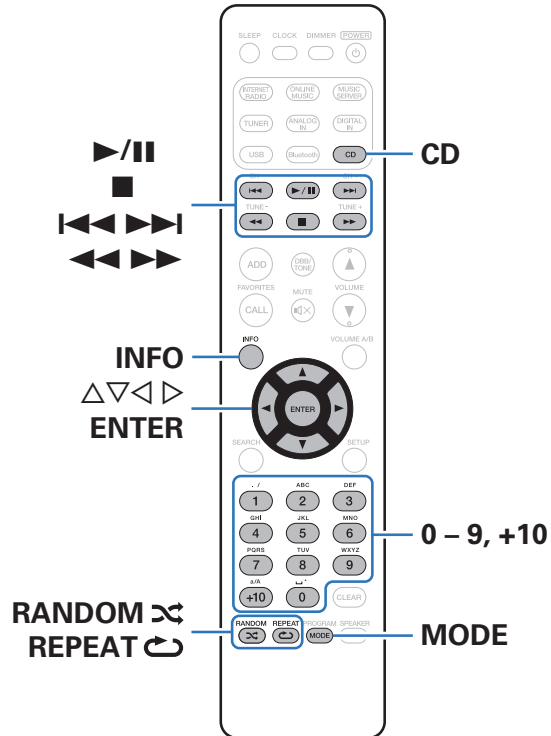

- This section explains how to playback MP3 and WMA files that are recorded onto a CD-R or CD-RW.
- There are many music distribution sites on the Internet allowing you to download music files in MP3 or WMA (Windows Media® Audio) format. The music (files) downloaded from such sites can be stored on CD-R or CD-RW discs and played on this unit.

“Windows Media” and “Windows” are the trademarks or registered trademarks of “Microsoft Corporation” in the United States and other countries.



Playing files

- 1 Press **CD** to switch the input source to “CD”.
- 2 Load a CD-R or CD-RW containing music files in the MP3 or WMA format into the disc tray. (👉 p. 133)
Playback starts.



- You can set whether to automatically play CDs. (👉 p. 96)

Operation buttons	Function
▶/	Playback / Pause
■	Stop
◀◀▶▶	Skip to previous track / Skip to next track
◀◀▶▶	(Press and hold) Fast-reverse / Fast-forward
△▽	Folder select
◀▶	File select
0 - 9, +10	Select the track
MODE	Switch playback mode <ul style="list-style-type: none"> • Switching between playing back all files within the selected folder or all tracks on the disc.
RANDOM 🔄	Random playback <ul style="list-style-type: none"> • Can be set during stop.
REPEAT 🔄	Repeat playback <ul style="list-style-type: none"> • Switching between Single-track repeat and All-track repeat.
INFO	Switching the artist name and album title display.



- The folder and file numbers are set automatically when the disc is loaded.

■ Files that can be played back

See “Playing back DATA CDs” (👉 p. 127).



Listening to Internet Radio

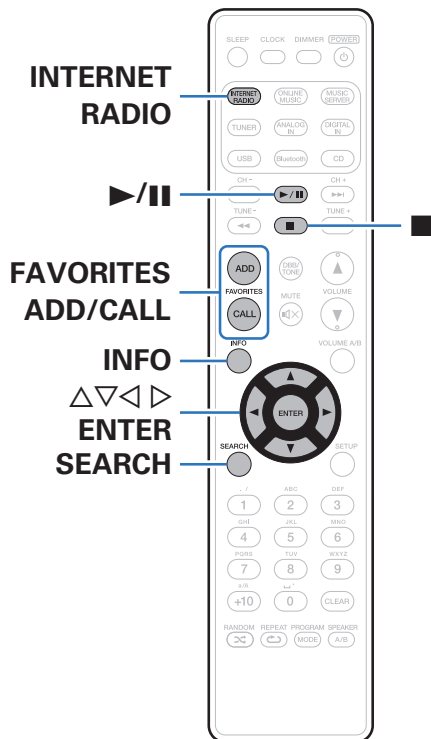

- Internet Radio refers to radio broadcasts distributed over the Internet. Internet Radio stations from around the world can be received.
- The broadcast station types and specifications supported by this unit for playback are as follows.

- **WMA**
- **MP3**
- **MPEG-4 AAC**



Listening to Internet Radio

This unit memorizes the last played Internet Radio station. If you press INTERNET RADIO to switch to the Internet Radio function from another input source, the last Internet Radio station you listened to is played.

1 Prepare for playback.

- Check the network environment, then turn on this unit's power. (☞ p. 28)

2 Press INTERNET RADIO.

3 Use $\Delta\nabla$ to select the you want to play, then press ENTER.

Country name :	Displays typical Internet Radio stations.
Search Stations :	Displays all Internet Radio stations that this unit can tune in to.
Search Podcasts :	Displays Internet Radio stations in the podcasts that this unit can tune in to.

Recommended Stations :

Displays recommended Internet Radio stations.

radiomarantz.com :

Displays Internet Radio stations added to favorites in vTuner. For instructions on how to add to favorites in vTuner, see "Using vTuner to add Internet Radio stations to favorites" (☞ p. 42).

Recently Played :

Displays recently played Internet Radio stations. Up to 20 stations can be stored in "Recently Played".



Search by Keyword :

Displays Internet Radio stations searched by keyword. For character input, see "Inputting characters" (☞ p. 92).

4 Use $\Delta\nabla$ to select the station, then press ENTER.

Playback starts once buffering reaches "100%".



Operation buttons	Function
	Playback
	Stop
FAVORITES CALL	Call from the Favorite list
FAVORITES ADD	Add to the Favorite list
	Character search
SEARCH	<ul style="list-style-type: none"> If the list is not in alphabetical order, you may not be able to perform a character search.
	Select the item
ENTER	Enter the selected item
INFO	Switching the file type/ bit rate and radio station name etc.



- Any characters that cannot be displayed are replaced with "." (period).

NOTE

- The radio station database service may be suspended or be otherwise unavailable without notice.

Playing the last played Internet Radio station

1 Press INTERNET RADIO.

The source switches to "Internet Radio" and the last played radio station plays.



Using vTuner to add Internet Radio stations to favorites

There are many Internet Radio stations in the world, and this unit can tune into these stations. But finding the radio station you want to hear may be difficult, because there are too many stations. If this is the case, then please use vTuner, an Internet Radio station search website specifically designed for this unit. You can use your PC to search Internet Radio stations and add them as your favorites. This unit can play radio stations added to vTuner.

- 1 Check the MAC address of this unit. “Network Information” (☞ p. 102)**
 - The MAC address is necessary when you create an account for vTuner.
- 2 Use your PC to access the vTuner website (<http://www.radiomarantz.com>).**
- 3 Enter the MAC address of this unit, then click “Go”.**
- 4 Enter your E-mail address and a password of your choice.**

- 5 Select the search criteria (genre, region, language, etc.) of your choice.**
 - You can also enter a keyword to search for a station you want to hear.
- 6 Select the radio station of your choice from the list, and then click the Add to Favorites icon.**
- 7 Enter the name of the favorite group, then click “Go”.**

A new favorite group that includes the selected radio station is created.

 - Internet Radio stations added to favorites in vTuner can be played from “radiomarantz.com” (☞ p. 40) with this unit.

■ Files that can be played back

See “Playing back Internet Radio” (☞ p. 130).



Playing back files stored on a PC and NAS

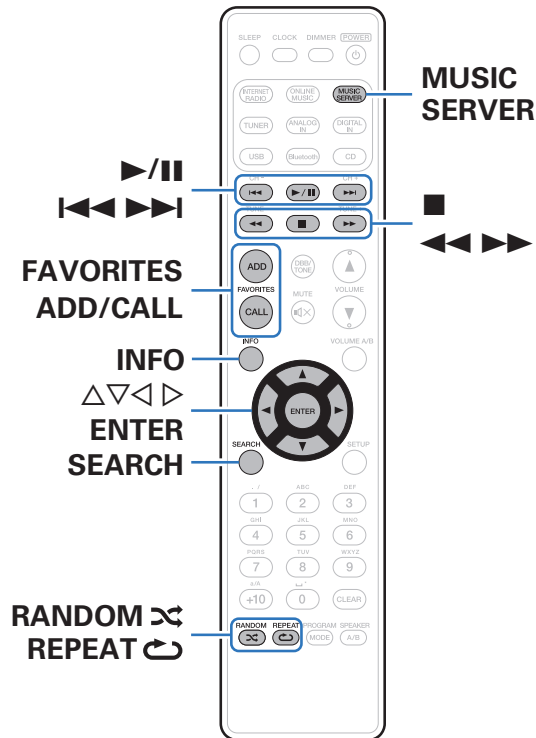

- This unit can play back music files and playlists (m3u, wpl) stored on a PC and on Network Attached Storage (NAS) that supports DLNA.
- The network audio playback function of this unit connects to the server using technologies shown below.
 - Windows Media Player Network Sharing Service
- This unit can play back the following files.
 - WMA
 - MP3
 - WAV
 - MPEG-4 AAC
 - FLAC
 - ALAC
 - AIFF
 - DSD (2.8 MHz)



Applying media sharing settings

Here, we apply the settings to share music files stored on a PC and NAS on the network.

If you are using a Media Server, be sure to apply this setting first.

■ When using Windows Media Player 12 (Windows 7 / Windows 8)

- 1 Start up Windows Media Player 12 on the PC.
- 2 Select “More streaming options...” in the “Stream”.
- 3 Select “Allowed” in the drop-down list for “Marantz M-CR611”.
- 4 Select “Allowed” in the drop-down list for “Media programs on this PC and remote connections...”.
- 5 Follow the instructions on the screen to complete the settings.

■ When using Windows Media Player 11

- 1 Start up Windows Media Player 11 on the PC.
- 2 Select “Media Sharing” in the “Library”.
- 3 Click the “Share my media” check box, select “Marantz M-CR611”, and then click “Allow”.
- 4 As you did in step 3, select the icon of the device (other PCs and mobile devices) you want to use as a media controller, and then click “Allow”.
- 5 Click “OK” to finish.

■ Sharing media stored on a NAS device

Change settings on the Network Attached Storage (NAS) device to allow this unit and other devices (PCs and mobile devices) used as media controllers to access the NAS. For details, see the owner’s manual that came with the NAS.



Playing back files stored on a PC and NAS

Use this procedure to play music files or playlists.

1 Prepare for playback.

- ① Check the network environment, then turn on this unit's power. "Connecting to a home network (LAN)" (👉 p. 28)
- ② Prepare the computer (👉 Computer's operating instructions).

2 Press MUSIC SERVER.

3 Use $\Delta \nabla$ to select the server including the file to be played, then press ENTER.

4 Use $\Delta \nabla$ to select the file, then press ENTER.

Playback starts once buffering reaches "100%".

Operation buttons	Function
	Playback / Pause
	Stop
	Skip to previous track / Skip to next track
	(Press and hold) Fast-reverse / Fast-forward
FAVORITES CALL	Call from the Favorite list
FAVORITES ADD	Add to the Favorite list
SEARCH	Character search <ul style="list-style-type: none"> • If the list is not in alphabetical order, you may not be able to perform a character search.
RANDOM	Random playback
REPEAT	Repeat playback <ul style="list-style-type: none"> • Switching between Single-track repeat and All-track repeat.
$\Delta \nabla \triangleleft \triangleright$	Select the item
ENTER	Enter the selected item
INFO	Switching the file type/bit rate, artist name, and album title.



■ Files that can be played back

See “Playing back files stored on PC or NAS” ( [p. 131](#)).



- WMA Lossless files can be played when using a server supporting transcoding, such as Windows Media Player Ver. 11 or later.

NOTE

- When playing back music files with your PC or NAS connected through wireless LAN, audio may be interrupted depending on your wireless LAN environment. In this case, play back music files with your PC or NAS connected through wired LAN.
- The order in which the tracks/files are displayed depends on the server specifications. If the tracks/files are not displayed in alphabetical order due to the server specifications, searching by the first letter may not work properly.



Listening to DAB/FM broadcasts

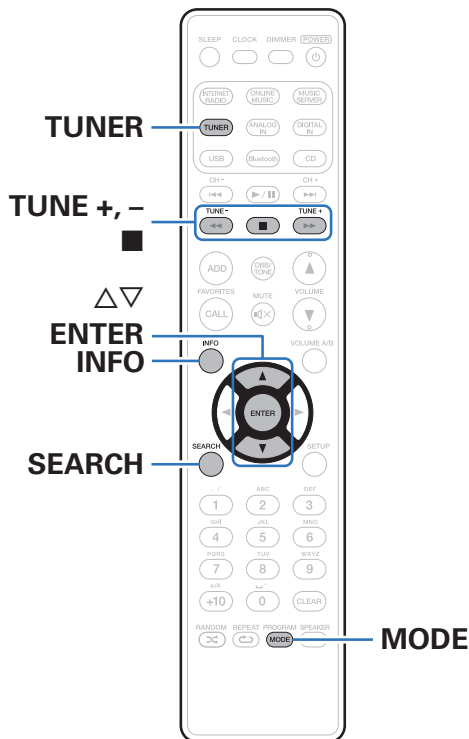

For details about how to connect the antenna, see “Connecting a DAB/FM antenna” (🔗 p. 27).

Listening to DAB/FM broadcasts

1 Press TUNER to select the reception band.

DAB: When listening to a DAB broadcast.

FM: When listening to an FM broadcast.

- When a DAB operation is performed for the first time after purchase, auto scanning is performed automatically.

2 Press TUNE + or TUNE – to select the station you want listen to.

When a station is received, the  will light.



Changing the FM tuning mode (Tune Mode)

You can change the mode for tuning into FM broadcasts. If you cannot tune in automatically with AUTO mode (AUTO), then change the mode to manual mode (No indication) and tune in manually.

1 Press MODE during FM reception.

Auto (AUTO):	Automatically search for and tune to a receivable radio station.
Manual (No indication):	Manually change the frequency one step at a time each time the button is pressed.

Automatically presetting FM stations (Auto Preset)

This unit can be preset to favorite list with a total of 50. For details on how to use Favorite, see “Favorite function” (📖 p. 53).

1 Press SEARCH during FM reception.

“Auto Preset” menu appears.

2 Use Δ / ∇ to select “Start” and then press ENTER.

The unit starts to tune in to radio stations automatically and preset them.

- When presetting is completed, “Complete!!” is displayed.



- To stop auto tuning, press ■.
- Broadcast stations whose antenna signals are weak cannot be preset automatically. If you wish to preset such stations, tune them in manually.
- When all 50 items in the favorites list are registered, no additional registrations can be made.



RDS Search

RDS is a broadcasting service which allows a station to send additional information along with the regular radio program signal.

Use this function to automatically tune to FM stations that provide the RDS service.

Note that the RDS function only works when receiving RDS compatible stations.

1 Press SEARCH during FM reception.

“Search” menu appears.

2 Use $\Delta \nabla$ to select “RDS Search”, then press ENTER.

3 Press ENTER.

The search for RDS stations begins automatically.



- The display switches between Program service name, Frequency, Program Type, and Radio Text each time the INFO is pressed.

PTY Search

Use this function to find RDS stations broadcasting a designated program type (PTY).

PTY identifies the type of RDS program.

The program types and their displays are as follows:

NEWS	News	WEATHER	Weather
AFFAIRS	Current Affairs	FINANCE	Finance
INFO	Information	CHILDREN	Children's program
SPORT	Sports	SOCIAL	Social Affairs
EDUCATE	Education	RELIGION	Religion
DRAMA	Drama	PHONE IN	Phone In
CULTURE	Culture	TRAVEL	Travel
SCIENCE	Science	LEISURE	Leisure
VARIED	Varied	JAZZ	Jazz Music
POP M	Pop Music	COUNTRY	Country Music
ROCK M	Rock Music	NATION M	National Music
EASY M	Easy Listening Music	OLDIES	Oldies Music
LIGHT M	Light Classical	FOLK M	Folk Music
CLASSICS	Serious Classical	DOCUMENT	Documentary
OTHER M	Other Music		



- 1 Press SEARCH during FM reception.**
“Search” menu appears.
- 2 Use $\Delta\nabla$ to select “PTY Search”, then press ENTER.**
- 3 Use $\Delta\nabla$ to call out the desired program type, then press ENTER.**
Automatically begin the PTY search operation.

TP Search

TP identifies programs that carry traffic announcements.

This allows you to easily find out the latest traffic conditions in your area before leaving home.

Use this function to find RDS stations broadcasting traffic programs (TP stations).

- 1 Press SEARCH during FM reception.**
“Search” menu appears.
- 2 Use $\Delta\nabla$ to select “TP Search”, then press ENTER.**
Automatically begin the TP search operation.



Radio Text

RT allows RDS stations to send text messages that appear on the display.



- When the RT mode is turned on while an RDS broadcast station not offering an RT service is tuned in, "NO TEXT" is displayed on the display.
- The operations described below selecting "RDS Search" will not function in areas in which there are no RDS broadcasts.

Listening to DAB

■ Tuning in DAB stations

1 Press TUNER to select "DAB".

- When a DAB operation is performed for the first time after purchase, auto scanning is performed automatically.

2 Press TUNE +, - to select the desired broadcast station.

- The broadcast stations are displayed in the order in which they were scanned.



- This unit can be preset to favorite list with a total of 50. For details on how to use Favorite, see "Favorite function" (📖 p. 53).



■ Auto scanning DAB broadcast stations

- 1 Press **SEARCH** during DAB reception.
- 2 Use **Δ∇** to select “Start”, then press **ENTER**.

After “Searching” is displayed, “_ _ Stations” is displayed. This unit searches for receivable DAB stations.

■ Switching the reception information for the currently tuned in DAB station

- 1 Press **INFO** during DAB reception.

Dynamic Label Segment:	Text data included in the broadcast is scrolled.
Station Name:	The service station name is displayed.
Program Type:	The category of the tuned in station is displayed.
Ensemble Name:	The ensemble name is displayed.
Frequency:	The frequency is displayed.
Signal Quality:	<p>The reception signal intensity is displayed (0 to 100).</p> <ul style="list-style-type: none"> • If the reception signal intensity is 80 or greater, the program can be received without noise.
Audio Information:	The mode of the currently tuned in station and its bit rate are displayed.



Favorite function

This section provides information on the Favorite function.

- The Favorite function allows you to register your favorite broadcast stations and files in the Favorite List in advance so that you can call and listen to the stations or files right away, whenever you want.
- The contents that you can register and call are Internet radio station, music server, tuner, USB and iPod (only when using “On-Display” mode).
- Up to 50 items can be stored in the Favorite List.

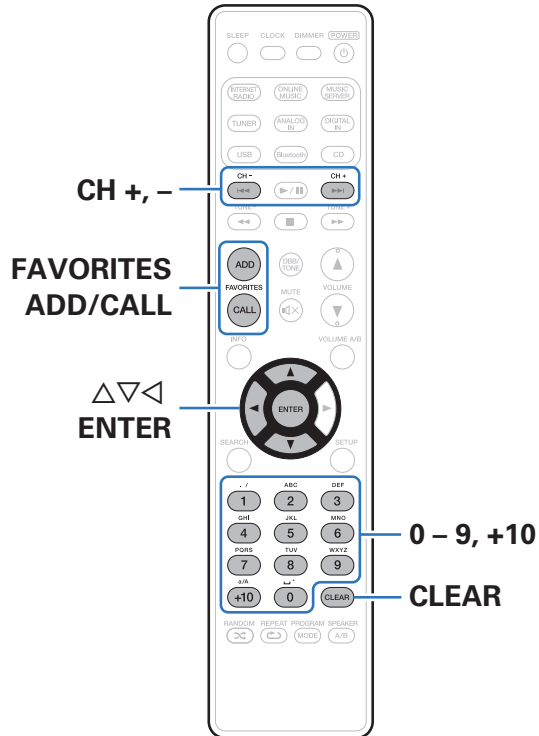

Registering stations or files to the favorites list

- 1 Press **FAVORITES ADD** while the Internet radio station or file to register is played back.
- 2 Use $\Delta\nabla$ to select a number to register the station or file, and press **ENTER**.
“Added To Favorites” is displayed and the registration is completed.

Calling stations or files from the favorites list

- 1 Press **FAVORITES CALL**.
- 2 Use **CH+**, **CH-** or $\Delta\nabla$ to select the station or file that you want to call, and press **ENTER**.
The respective function starts up and playback starts.



- Press 0 – 9, +10 to call files registered to the Favorite list by number.

To switch between registered stations and files during playback

- 1 Use **CH+**, **CH-** or $\Delta\nabla$.

Deleting stations or files from the favorite list

- 1 Press **FAVORITES CALL**.
- 2 Use $\Delta\nabla$ to select the station or file that you want to delete, and press **CLEAR**.
- 3 When the prompt “Delete?” appears, press **ENTER**.
“Deleted” is displayed and the deletion is completed.



- Press < to cancel the operation.



Playing an iPod

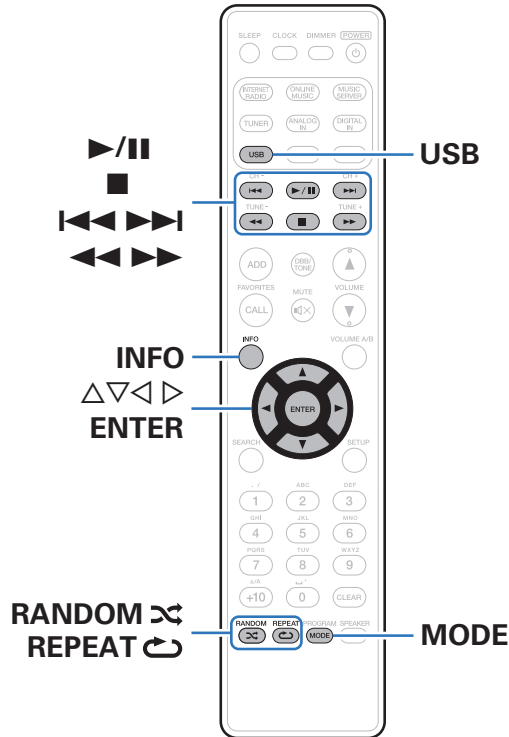

- You can use the USB cable provided with the iPod to connect the iPod with the unit's USB port and enjoy music stored on the iPod.
- For information on the iPod models that can be played back with this unit, see "Supported iPod/iPhone models" (🔗 p. 26).



Listening to music on an iPod

1 Connect the iPod to the USB port. (👉 p. 25)

When you connect iPod to the front USB port, the input source automatically switches to “Front USB”.

2 Press USB to switch the input source to “Front USB” or “Rear USB”.

“From iPod” is displayed on the display of this unit.

3 Operate iPod itself directly while seeing the iPod screen to play back music.



- The iPod display modes include “From iPod” and “On-Display”. By default, “From iPod”, where you directly operate the iPod itself while looking at the iPod screen, is set.
- To change to “On-Display” where operations are performed while the iPod information is displayed on this unit, see “Setting operation mode (“On-Display” mode)” (👉 p. 57).
- You can also listen to iPod music using “AirPlay function” (👉 p. 68).

NOTE

- Depending on the type of iPod and the software version, some functions may not operate.
- Note that Marantz will accept no responsibility whatsoever for any problems arising with the data on an iPod when using this unit in conjunction with the iPod.



Setting operation mode (“On-Display” mode)

In this mode, various lists and screens during playback on the iPod are displayed on the body.

This section describes the steps up to playing back tracks on the iPod in “On-Display”.

- 1 Press **MODE** and display “On-Display”.
- 2 Use $\Delta \nabla$ to select the file to be played, then press **ENTER**.

Playback starts.

Display mode		From iPod	On-Display
Playable files	Music file	✓	✓
	Video file	*	
Active buttons	Remote control unit (This unit)	✓	✓
	iPod	✓	

* Only the sound is played.

Operation buttons	Function
	Playback / Pause
	Stop
	Skip to previous track / Skip to next track
	(Press and hold) Fast-reverse / Fast-forward
	Random playback
	Repeat playback <ul style="list-style-type: none"> • Switching between Single-track repeat and All-track repeat.
MODE	Switching between On-Display or From iPod mode.
$\Delta \nabla \triangleleft \triangleright$	Select the item
ENTER	Enter the selected item
INFO	Switching the artist name and album title.

NOTE

- Marantz will accept no responsibility whatsoever for any loss of iPod data.
- Depending on the type of iPod and the software version, some functions may not operate.



Charging the iPod/iPhone

You can charge your iPod/iPhone by connecting it to USB port.

■ Standby charging

If the unit enters power standby mode while the iPod/iPhone is charging, the unit will switch to standby charging mode, and the iPod/iPhone will continue to be charged. When in standby charging mode, the power indicator lights turns red.

When the iPod/iPhone is fully charged, the unit automatically stops supplying power for charging and enters normal power standby mode, and the power indicator lights turns off.



Playing a USB memory device

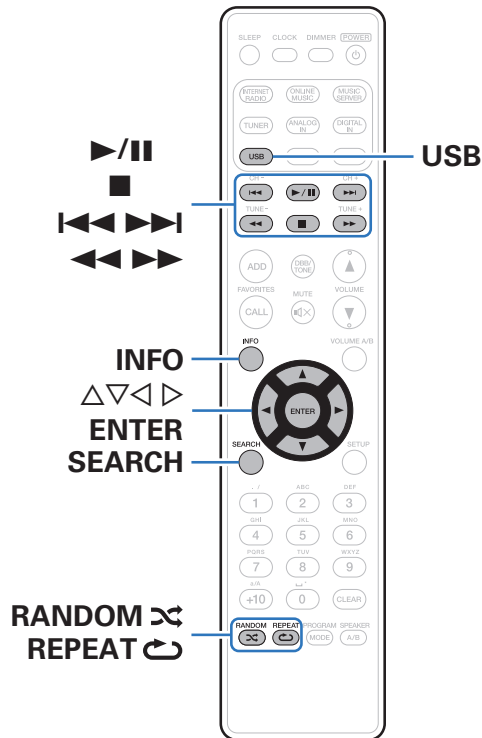

- Playing back music files stored on a USB memory device.
- Only USB memory devices conforming to mass storage class and MTP (Media Transfer Protocol) standards can be played on this unit.
- This unit is compatible with USB memory devices in “FAT16” or “FAT32” format.
- This unit can play back the following files.
 - MP3
 - WMA
 - WAV
 - MPEG-4 AAC
 - FLAC
 - ALAC
 - AIFF
 - DSD (2.8 MHz)



Playing files stored on USB memory devices









1 Connect the USB memory device to the USB port. (p. 25)

When you connect USB memory device to the front USB port, the input source automatically switches to “Front USB”.

2 Press **USB** to switch the input source to “Front USB” or “Rear USB”.

3 Use $\Delta \nabla$ to select the file to be played, then press **ENTER**.

Playback starts.

Operation buttons	Function
	Playback / Pause
	Stop
	Skip to previous track / Skip to next track
	(Press and hold) Fast-reverse / Fast-forward
RANDOM 	Random playback
REPEAT 	Repeat playback <ul style="list-style-type: none"> Switching between Single-track repeat and All-track repeat.
SEARCH	Character search <ul style="list-style-type: none"> If the list is not in alphabetical order, you may not be able to perform a character search.
$\Delta \nabla$  	Select the item
ENTER	Enter the selected item
INFO	Switching the artist name and album title.

NOTE

- Note that Marantz will accept no responsibility whatsoever for any problems arising with the data on a USB memory device when using this unit in conjunction with the USB memory device.

■ Files that can be played back

See “Playing back USB memory devices” ( p. 128).



Listening to music on a Bluetooth device

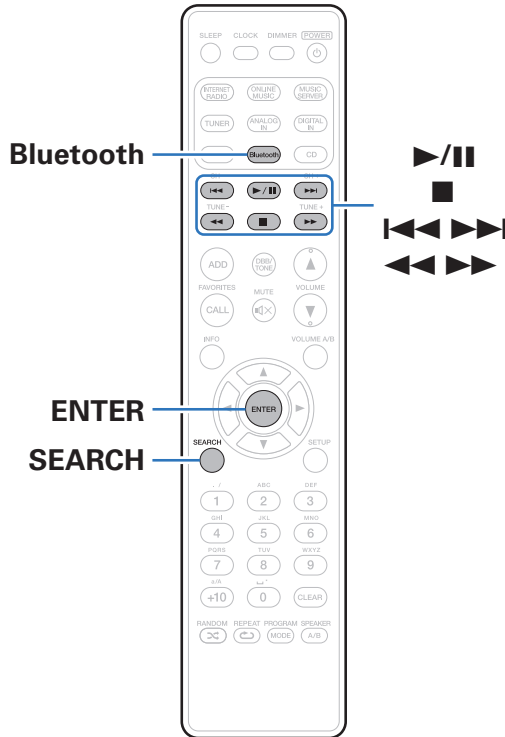

Music files stored on Bluetooth devices such as smartphones, digital music players, etc. can be enjoyed on this unit by pairing and connecting this unit with the Bluetooth device.

Communication is possible up to a range of about 10 m.

NOTE

- To play back music from a Bluetooth device, the Bluetooth device needs to support the A2DP profile.



Playing music from Bluetooth device

In order to enjoy music from a Bluetooth device on this unit, the Bluetooth device must first be paired with this unit.

Once the Bluetooth device has been paired, it does not need to be paired again.

1 Press Bluetooth to switch the input source to “Bluetooth”.

When using for the first time, the unit will go into the pairing mode automatically and “Pairing Mode” will appear on the display of the unit.

2 Activate the Bluetooth settings on your mobile device.

3 Select this unit when its name appears in the list of devices displayed on the screen of the Bluetooth device.

Connect to the Bluetooth device while “Pairing Mode” is being displayed on the display of the unit.

Perform the connection with the Bluetooth device close to the unit (about 1 m).

4 When a number appears on the display of this unit, check that it is the same number as that shown on the screen of the Bluetooth device and then select “pair” for both the Bluetooth device and the unit. (To select “pair” on this unit, press ENTER on the unit.)

At the end of the pairing, the device name appears on the display of this unit.





5 Play music using any app on your Bluetooth device.

- The Bluetooth device can also be operated with the remote control of this unit.
- The next time the input source is switched to Bluetooth, this unit automatically connects to the last Bluetooth device that was connected.



- Enter “0000” when the password is requested on the screen of the Bluetooth device.



Operation buttons	Function
	Playback / Pause
	Stop
	Skip to previous track / Skip to next track
	(Press and hold) Fast-reverse / Fast-forward



- Press INFO on the remote control unit during playback to switch the display between Artist name, Album name, etc.
- Incompatible characters are displayed as “.” (period).

NOTE

- To operate the Bluetooth device with the remote control of this unit, the Bluetooth device needs to support the AVRCP profile.
- The remote control of this unit is not guaranteed to work with all Bluetooth devices.
- Depending on the type of Bluetooth device, this unit outputs audio that is coupled to the volume setting on the Bluetooth device.



Pairing with other Bluetooth devices

Pair a Bluetooth device with this unit.

1 Activate the Bluetooth settings on your mobile device.

2 Press SEARCH when the input source is “Bluetooth”.

The device will go into the pairing mode.

3 Select this unit when its name appears in the list of devices displayed on the screen of the Bluetooth device.

4 When a number appears on the display of this unit, check that it is the same number as that shown on the screen of the Bluetooth device and then select “pair” for both the Bluetooth device and the unit. (To select “pair” on this unit, press ENTER on the unit.)

At the end of the pairing, the device name appears on the display of this unit.



- This unit can be paired with a maximum of 8 Bluetooth devices. When a 9th Bluetooth device is paired, it will be registered in place of the oldest registered device.
- Enter “0000” when the password is requested on the screen of the Bluetooth device.
- Either press and hold Bluetooth for 3 seconds, or switch the input source to “Bluetooth” and then press and hold INPUT on this unit for more than 3 seconds to switch to pairing mode.



Reconnecting to this unit from a Bluetooth device

After pairing is completed, the Bluetooth device can be connected without performing any operations on this unit.

This operation also needs to be performed when switching the Bluetooth device for playback.

- 1 If a Bluetooth device is currently connected, deactivate the Bluetooth setting of that device to disconnect it.**
- 2 Activate the Bluetooth setting of the Bluetooth device to be connected.**
- 3 Select this unit from the Bluetooth device list on your Bluetooth device.**
- 4 Play music using any app on your Bluetooth device.**



- When the power of this unit is turned on, the input source will be automatically switched to “Bluetooth” if a Bluetooth device is connected.
- When the “Network Control” setting of this unit is set to “On” and a Bluetooth device is connected with the unit in the standby state, the power of the unit will be turned on automatically.



Connecting a Bluetooth device with the NFC function via NFC

You can just touch this unit with a Bluetooth device to turn on power to this unit and perform pairing or establish a connection between this unit and the Bluetooth device.

1 Turn on the NFC function on the Bluetooth device.

- For details, see the owner's manual for your Bluetooth device.

2 Touch **N** on this unit with the NFC antenna part on the Bluetooth device.

If a pairing confirmation screen is displayed, follow the instructions on this unit and the Bluetooth device to complete pairing.

- Complete operations as instructed by the Bluetooth device.

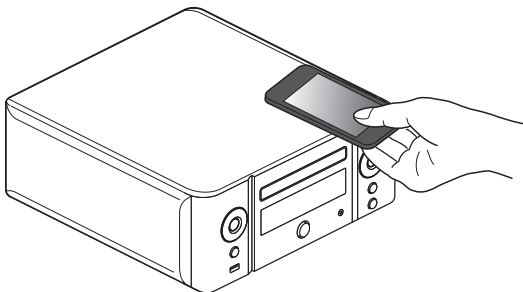

3 Play back music on the Bluetooth device.

This unit outputs music from the Bluetooth device.



- When "Network Control" is set to "On", startup and connection can be performed even when the unit power is off.
- When you touch the N mark (**N**) on this unit with the Bluetooth device that is playing back music, this unit outputs that music.
- Touch the N mark (**N**) again during the Bluetooth connection to disconnect the connection.
- Touch the N mark (**N**) again if pairing or connection with the Bluetooth device fails.

NOTE

- Before establishing a NFC connection, cancel the lock function on the Bluetooth device.
- When you touch this unit with a Bluetooth device, do so softly.



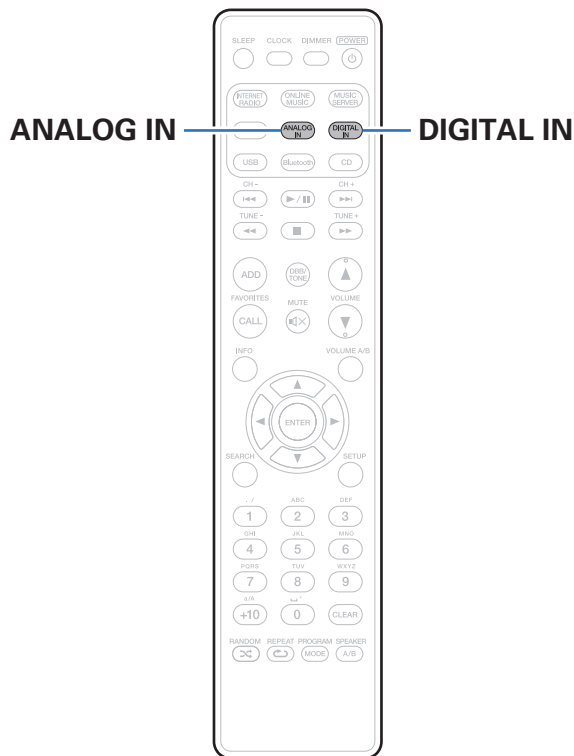

Listening to DIGITAL IN

- 1 Prepare for playback.**
Check the connection, then turn on this units.
 - 2 Press DIGITAL IN to select “Optical In 1” or “Optical In 2”.**
 - 3 Play the component connected to this unit.**
-  Only 2-channel linear PCM digital audio signals can be inputted through the DIGITAL IN connector of this unit.

Listening to ANALOG IN

- 1 Prepare for playback.**
Check the connection, then turn on this units.
- 2 Press ANALOG IN to select “Analog In”.**
- 3 Play the component connected to this unit.**



AirPlay function

Music files stored on your iPhone, iPod touch, iPad or iTunes can be played on this unit via the network.



- You can stop AirPlay playback by pressing < or choosing other input source.
- To see song and artist names together, press INFO on the remote control unit.
- For information about how to use iTunes, also see the Help for iTunes.
- The screen may differ depending on the OS and software versions.

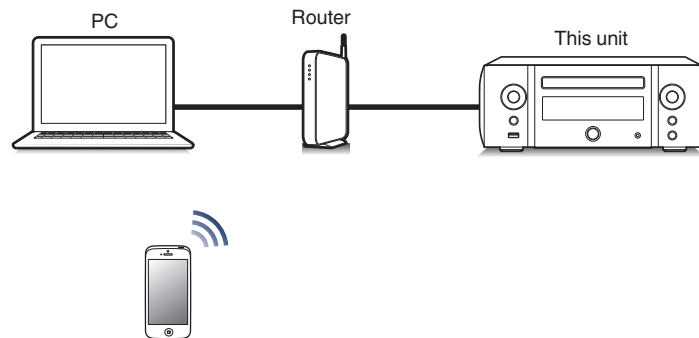

Playing songs from your iPhone, iPod touch or iPad

If you update your “iPhone/iPod touch/iPad” to iOS 4.2.1 or later, you can stream music stored in your “iPhone/iPod touch/iPad” directly to this unit.

1 Connect your iPhone, iPod touch or iPad Wi-Fi to the same network as this unit.

- For details, see your device’s manual.

2 Play the song on your iPhone, iPod touch or iPad.

 is displayed on the iPhone, iPod touch or iPad screen.

3 Tap the AirPlay icon .

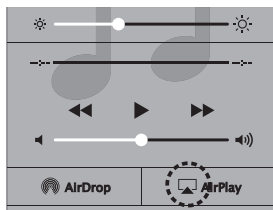

4 Select this unit.

Playing iTunes music with this unit

1 Install iTunes 10, or later, on a Mac or Windows PC that is connected to the same network as this unit.

2 Turn this unit ON.

Set “Network Control” to “On” for this unit. ( p. 102)

NOTE

- When “Network Control” is set to “On”, the unit consumes more standby power.

3 Start iTunes and click the AirPlay icon to select the main unit.



4 Choose a song and click play in iTunes.

The music will stream to this unit.



Selecting multiple speakers (devices)

It is possible to play iTunes songs on your home's AirPlay compatible speakers (devices) other than those of this unit.

- 1 Click the AirPlay icon  and select "Multiple".
- 2 Check the speakers you want to use.

NOTE

- In playback using the AirPlay function, the sound is output at the iPhone, iPod touch, iPad or iTunes volume setting level.
You should turn down the iPhone, iPod touch, iPad or iTunes volume prior to playback and then adjust it to a suitable level.



Spotify Connect function

Spotify is the world's most popular streaming service. If you subscribe to Spotify Premium, you can control your new speaker with your phone or tablet. Because Spotify is built-in to your speaker, you can still take calls or use other apps - the music never stops.

For information on how to set up and use Spotify Connect please visit www.spotify.com/connect

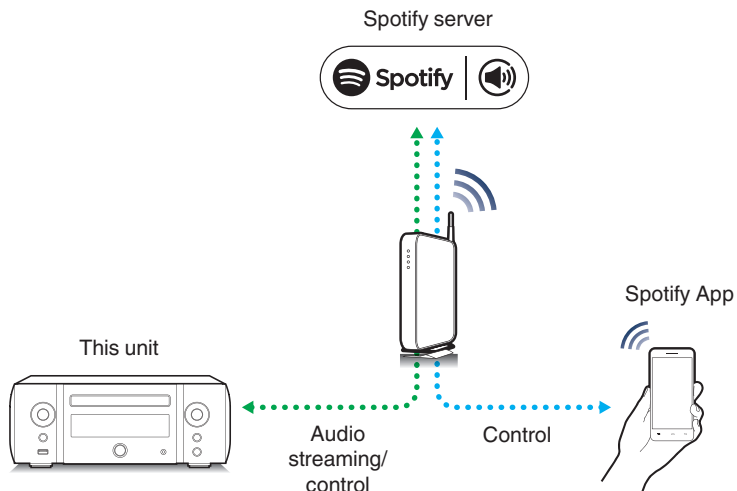

Playing Spotify music with this unit

Download the "Spotify App" onto your Android or iOS device beforehand. To play a Spotify track in this unit, you need to register in the Spotify premium account first.

- 1 Connect the Wi-Fi settings of the iOS or Android device in the same network as this unit.**
- 2 Launch the Spotify App.**
- 3 Play back the Spotify track.**
- 4 Tap the  icon to select the unit.**
The music will stream to this unit.

Remote play function

You can use your home network to play back with this unit music files stored on PC, NAS, smartphones and portable audio players.

In this case, you use PC, smartphones and portable audio players for operations.



- The relevant devices should comply with the DLNA (Digital Living Network Alliance) Ver. 1.5 standard.
- A wireless LAN environment is required for playing back music files on smartphones or portable audio players.
- For some smartphones, you must install an application for DLNA music playback.

Roles each device plays

The following devices are used for Remote Play. As specified in the DLNA standard, these devices are called DMC, DMS or DMR according to their role.

Name	Device example	Role
DMC (Digital Media Controller)	<ul style="list-style-type: none"> • PC • Smartphone • Portable audio player • Marantz Hi-Fi Remote 	Performs Remote Play operations. DMC can also play back music files stored on these devices.
DMS (Digital Media Server)	<ul style="list-style-type: none"> • PC • NAS (Network Attached Storage) 	Stores music files. Music files stored on these devices are played back with DMC.
DMR (Digital Media Renderer)	<ul style="list-style-type: none"> • This unit 	Outputs audio of music files played back through Remote Play from speakers. DMR cannot perform playback operations.

Files that can be played back

See “Playing back files stored on PC or NAS” ( p. 131).



Settings required for each device

You must make settings on DMC and DMS for Remote Play. Make the following settings. Also see the owner's manual of each device for settings.

■ Settings on computer and NAS

Make settings on computer and NAS to exchange data with DMR devices.

For details on the settings, see "Applying media sharing settings" (🔍 p. 44).

■ Settings on smartphones

You must install an application for DLNA music playback on your smartphone to perform operations on DMS and this unit (DMR) with your smartphone. The applicable application differs according to your smartphone.



- Some smartphones support DLNA music playback with the factory settings. See the owner's manual of your smartphone.

■ Settings on portable audio players

Configure the settings so that this unit (DMR) can play back music files stored on your portable audio player. For details on the settings, see the owner's manual of your portable player.

■ Settings on this unit

Connect this unit to the DLNA network. You do not need to make other settings.

For the network connection, see the provided "Quick Setup Guide", "Connecting to a home network (LAN)" (🔍 p. 28) and "Settings" (🔍 p. 104).



■ Remote Play operations

Operations are different for each device, but the procedures for preparing for Remote Play are the same. The preparation procedures are shown below.

1 Turn on this unit.

- Make sure that this unit is connected to the network.

2 Display the music file playback screen on DMC.

- For PC, open Windows Media Player 12, etc.
- For smartphones, switch to the music file playback mode.

3 Select the friendly name of this unit for the item that sets the playback device on the playback screen.

- The default Friendly Name of this unit is “Marantz M-CR611”.

4 Start playing back a music file on DMC.

- The function on this unit automatically switches to “Music Server” and the Remote Play mark  appears on the display. Remote Play starts.



- Press < to exit Remote Play mode.

NOTE

- During Remote Play, you cannot perform playback operations with this unit. Use the DMC device for these operations.



Web control function

You can control this unit from a web control screen on a web browser.

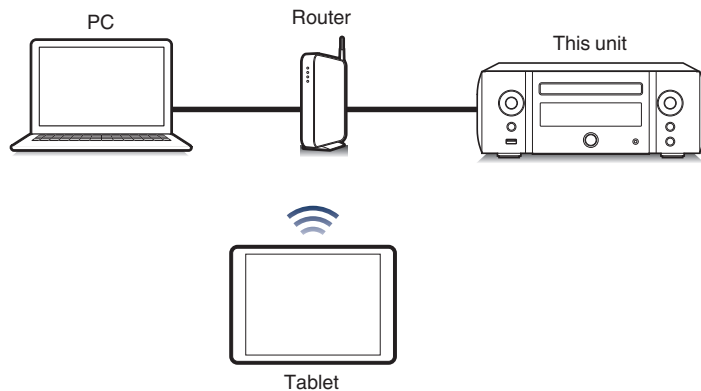

- This unit and the PC or tablet need to be connected to the network properly in order to use the web control function. “Connecting to a home network (LAN)” (☞ p. 28)
- Depending on the settings of your security-related software, you may not be able to access this unit from your PC. If this is the case, then change the settings of the security-related software.

Controlling the unit from a web control

- 1 Switch the “Network Control” setting to “On”. (☞ p. 102)
- 2 Check the IP address of this unit with “Network Information”. (☞ p. 102)



Checking the IP address.

- 3 Start up the web browser.



4 Enter the IP address of this unit in browser's address box.

For example, if the IP address of this unit is "192.168.0.2", enter "http://192.168.0.2".

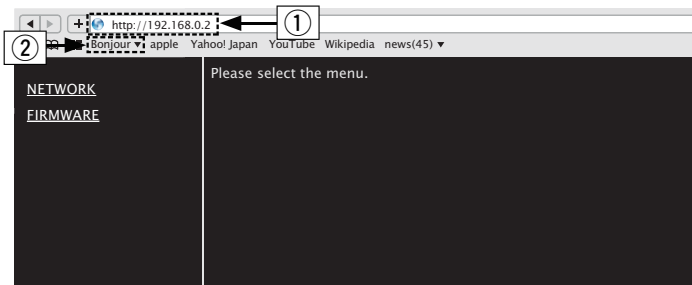

- ① Entering the IP address.
- ② If you are using the Safari web browser, you can select "Bonjour" and directly access the unit's web control screen from the overview section.



- By adding this unit's IP address to the browser's bookmark, you can display the web control screen using the bookmark function the next time you use the browser. If you are using a DHCP server and "Network Control" (🔧 p. 102) is set to "Off", turning the power on/off changes the IP address.

5 When the top menu is displayed, click on the menu item you want to operate.

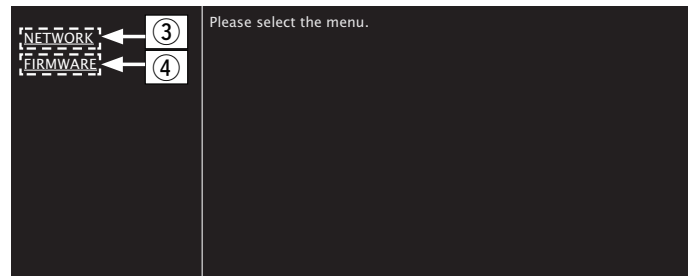

- ③ Click when you setup network settings. (🔧【Example 1】)
- ④ Click when you update firmware.



6 Operate.

[Example 1] Network Setting 1

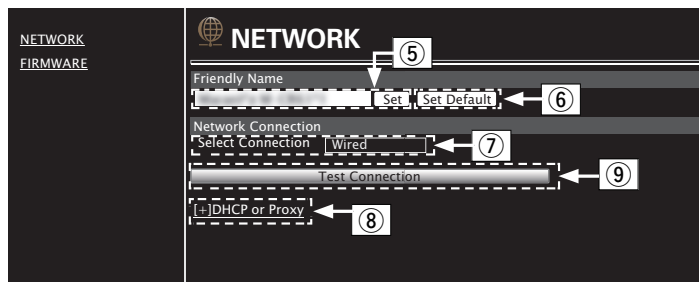

❑ Friendly Name setting

- ⑤ To change the Friendly Name, enter the new name in the text box and click "Set".
- ⑥ To reset the Friendly Name, click "Set Default".



- Only characters that can be displayed on this unit can be set. (📖 p. 92)

❑ Network connection settings

- ⑦ Click to change the network connection method. If you select "Wi-Fi", a new item will appear on-screen. (📖 [Example 2])
- ⑧ Click to change DHCP/proxy settings. (📖 [Example 2])
- ⑨ Click to connect using the newly applied settings.



7 Operate.

[Example 2] Network Setting 2

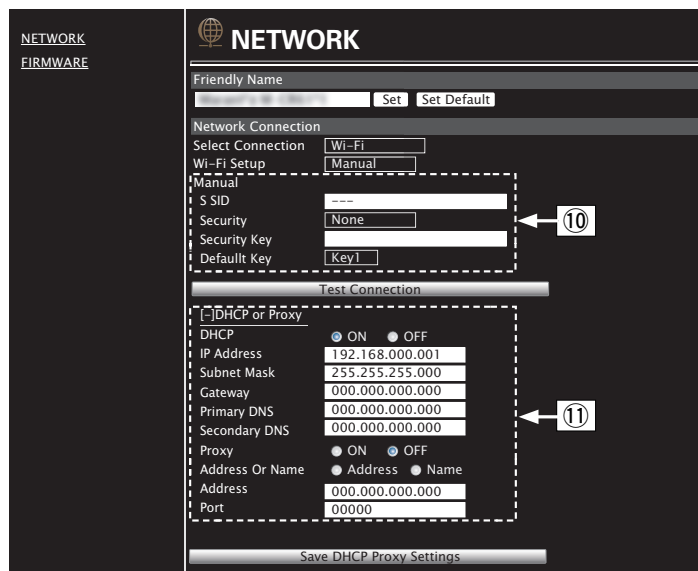

❑ Network connection settings

- ⑩ **[Example 2]** - Displayed when “Wi-Fi” is selected in ⑦. Select or input items as necessary, and then click “Test Connection” to apply the changes.
- Items displayed may vary depending on selected items and connection status.
 - After selecting each item, wait a moment for the display to be updated.
- ⑪ **[Example 2]** - Displayed when “DHCP” or “Proxy” is selected in ⑧. When changing DHCP/proxy settings, input or select for each item.



- To apply network connection settings, click “Test Connection” after making changes.



Update on web screen

“Web control function” (☞ p. 75) settings must be completed in advance on a computer belonging to the same network. For information on obtaining update files, please contact our customer service center.

1 Click ④ from step 5 for the “Web control function”. (☞ p. 75)

The PC will display the following screen.

Wait for approximately 1 minute.

You can also gain access by entering the IP address shown by the unit into a web browser.

[The web display]

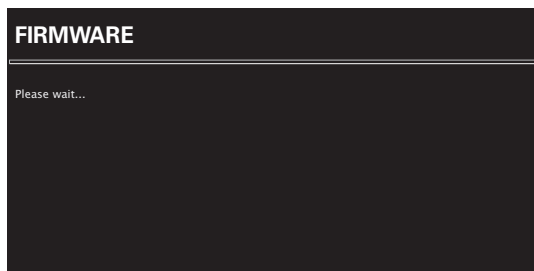

[The unit's screen display]

IpAddress
192.168.xxx.xxx

2 When the following screen is displayed by the PC, click the “Choose File” (①) button, select the update file, and click the “Upload” (②) button.

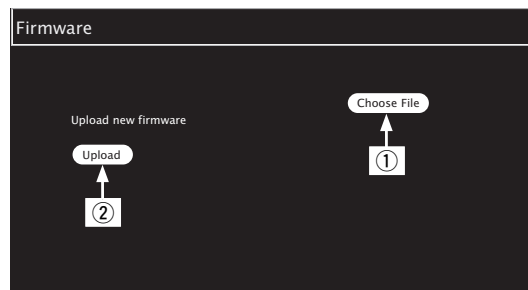

3 Click “OK”.

Updating will begin.

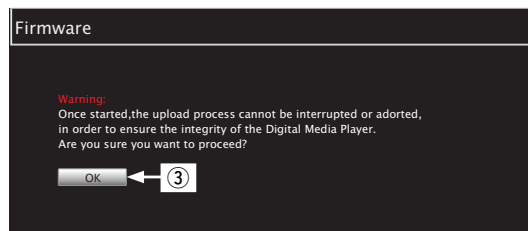

NOTE

- Do not operate the unit while updating is in progress.



4 When the following screen is displayed, updating is complete.

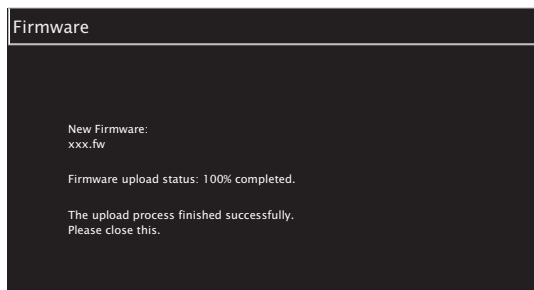

- Button names may vary depending on the OS language used on your computer.



Convenience functions

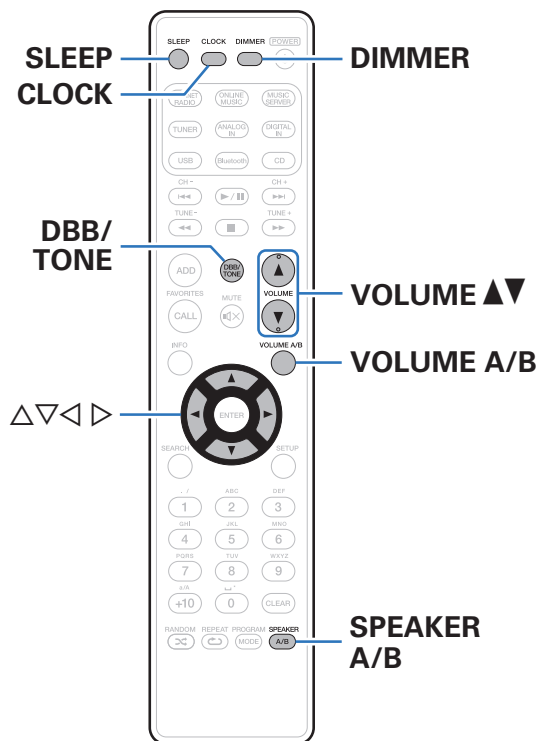

Adjusting the tone	82
Sleep timer function	83
Checking the current time	83
Switching the display's brightness	84
Listening to music in two locations using a multi-drive connection	85



Adjusting the tone

- 1 Press **DBB/TONE** to select the tone parameter to be adjusted.
- 2 Use $\Delta \nabla$ to adjust the “Dynamic Bass Boost”, “Bass”, “Treble”, “Balance” or “S.Direct”.

Dynamic Bass Boost

Emphasizes the bass sound in stages according to the volume (maximum +8 dB).

On / Off (Default: Off)

Bass

Adjusts the bass sound.

-10dB – +10dB (Default : 0dB)

Treble

Adjusts the treble sound.

-10dB – +10dB (Default : 0dB)

Balance

Use $\triangleleft \triangleright$ to adjust the left/right volume balance.

S.Direct

The “Dynamic Bass Boost”, “Bass”, “Treble” and “Balance” are not adjusted.

On / Off (Default: Off)



- When “Response” is set to other than “Flat”, the setting is enabled even if “S.Direct” is “On”. (🔗 p. 97)



Sleep timer function

You can have the power automatically switched to standby once a set time has elapsed. This is convenient for listening while going to sleep.

1 Press SLEEP during playback and select the setting time.

- The  indicator on the display lights.
- You can set the sleep timer in the range from 10 to 90 minutes in steps of 10 minutes.

■ To cancel the sleep timer

Press SLEEP to set "Sleep ▶Off".

The  indicator on the display turns off.



- The sleep timer setting is canceled when the unit switches to standby mode.
- To check the time remaining until the sleep timer is activated, press SLEEP.

Checking the current time

■ Checking the current time when the power is on

Press CLOCK.

- Press once more and the display returns to its original condition.

■ Checking the current time when the power is set to standby

Press CLOCK.

- The current time is displayed for 30 seconds.



- The time cannot be set when in the standby mode. Turn on the power first.



Switching the display's brightness

1 Press DIMMER.

- The brightness of the display switches each time the button is pressed (5 levels).
- The Front panel illumination brightness also changes to match the display brightness.



- If the buttons are operated when the display is turned off, information is displayed temporarily at a low brightness level.



Listening to music in two locations using a multi-drive connection

You can listen to music in different rooms using this unit with two pairs of speaker systems.

■ Connecting the speaker cables

Carefully check the left (L) and right (R) channels and + (red) and – (black) polarities on the speakers being connected to the unit, and be sure to connect the channels and polarities correctly.

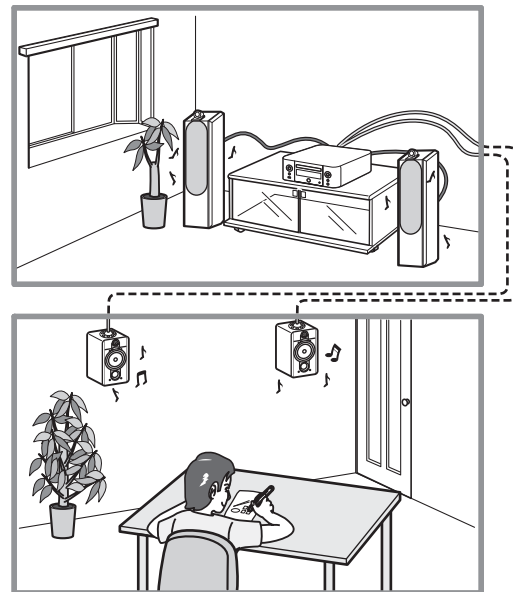
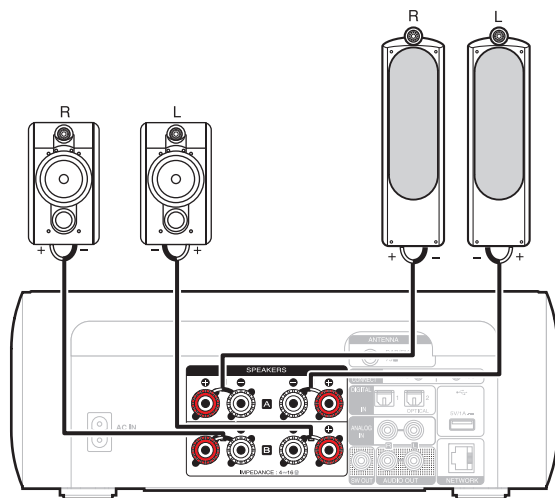

■ Selecting speakers to output audio

You can set up this unit to output audio from Speaker A, Speaker B, or both.

1 Press SPEAKER A/B.

The current setting is displayed.

2 Press SPEAKER A/B again to change the settings.

Speaker A = On :

Outputs audio from Speaker A only.

Speaker B = On :

Outputs audio from Speaker B only.

Both Speakers A and B = On :

Outputs audio from both Speaker A and Speaker B.



- When using this connection, also set “Bi-Amp” in the menu to “Disable”.
( p. 96)
- When “Both Speakers A and B = On” is set for the output audio speakers and AirPlay or Remote Play is used on an external devices or a Bluetooth operation is performed on an iOS device, the volume display on the external device or iOS device follows the volume of Speaker A.

■ Specifying speakers to adjust the volume

When 2 sets of speakers (Speaker A/Speaker B) are connected, either Speaker A or Speaker B can be selected for volume adjustment.

1 Press VOLUME A/B.

The speakers whose volume is to be adjusted are shown in the unit display.

2 Press VOLUME ▲▼ to adjust the volume.

NOTE

- This is only enabled when “Both Speakers A and B = On” is set for the audio output speakers.



Menu map

For menu operations, see the following page.

By default, this unit has recommended settings defined. You can customize this unit based on your existing system and your preferences.

■ Quick Setup

Setting items	Description	Page
Quick Setup	Performs the network settings using a Wizard style window. For details on the operations, see the separate "Quick Setup Guide".	-



■ General

Setting items	Description	Page
Alarm	Sets the timer playback.	94
Clock	Sets the current time.	95
Clock Mode	The clock is constantly displayed.	95
Volume Limit	Make a setting for maximum volume.	96
CD Auto Play	Set whether or not to automatically play a disc when the disc is inserted.	96
Speaker Configuration	Indicate speaker presence and select speaker size categories based on bass reproduction capability.	96
Bi-Amp	Sets the Bi-Amp mode.	96
Response	Set the output frequency characteristics.	97
Illumination	Changes/turns off the Front panel illumination color.	97
Audio Out	You can set whether to “Fixed” or “Variable” the analog audio output level.	98
Language	Sets the language for display the menu.	98
Auto-Standby	Sets the unit power to standby when the unit is not in use.	98
Usage Data	Selects whether or not to send anonymous usage data to Marantz.	99
Firmware	Set whether or not to check for firmware update, update the firmware, and display update and upgrade notifications.	99
Update	Update the firmware of this unit.	99
Notifications	Set the Update, Upgrade and Alerts notification on/off.	100
Add New Feature	Display new features that can be downloaded to this unit and perform an upgrade.	100
Reset	Resetting factory settings.	101



■ Network

Setting items	Description	Page
Network Information	Displays various information about the network.	102
Network Control	Performs the ON/OFF settings for the network function when in standby mode.	102
Friendly Name	Edits a name displayed on the Internet.	103
Wi-Fi	Enables/disables the Wi-Fi function.	103
Bluetooth	Enables/disables the Bluetooth function.	103
Settings	Performs the settings for a wired or wireless LAN.	104
Wired Setup	Performs the settings for a wired LAN.	104
DHCP (On) orDHCP (Off)	Performs the DHCP setting.	104
IP Address *	Performs the IP address setting.	104
Subnet Mask *	Performs the subnet mask setting.	104
Gateway *	Performs the gateway setting.	104
Primary DNS *	Performs the primary DNS setting.	104
Secondary DNS *	Performs the Secondary DNS setting.	104
Proxy	Performs the proxy setting.	105
Test Connection	Performs the wired LAN connection.	–
Wi-Fi Setup Method	Performs the wireless LAN connection setting.	105
Auto-Scan	Selects and sets the wireless connections from the access point list.	106
Share Wi-Fi setting from an iOS device	Sets the wireless connection using an iOS device. (iOS version 7 or later)	106
WPS (Wi-Fi Protected Setup)	Sets the wireless connection using WPS (Wi-Fi Protected Setup).	106
Web Browser Setup	Sets the wireless connection using web browser.	107
Manual	Sets the wireless connection manually.	109

* Displayed when the "DHCP" setting is "Off". (☞ p. 104)



■ DAB (Only displayed when DAB Source is selected.)

Setting items	Description	Page
Tuning Aid	Displays the reception intensity for DAB antenna installation.	110
Station Order	Sets the order of broadcasting stations to be displayed.	110
DRC	Sets dynamic range control.	110
DAB Initialize	Resets the DAB modules.	110
DAB Version	Displays DAB module version.	110



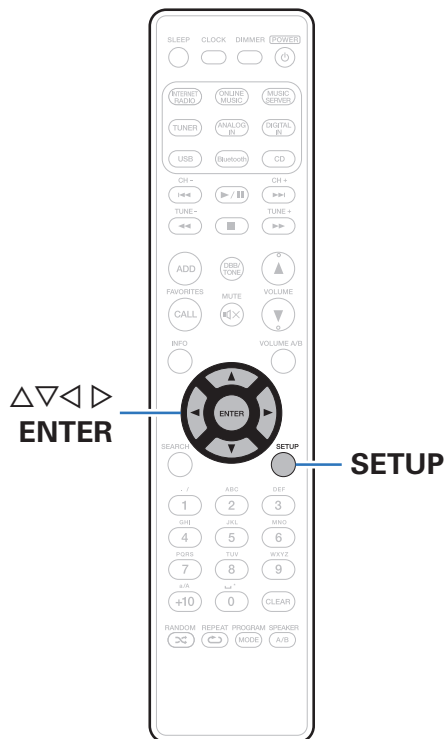

Menu operation

- 1 Press SETUP.**
The menu is displayed.
- 2 Use $\Delta \nabla \triangleleft \triangleright$ to select the menu to be set or operated, then press ENTER.**
- 3 Use $\Delta \nabla$ to change to desired setting.**
- 4 Press ENTER to enter the setting.**
 - To return to the previous item, press \triangleleft .
 - Exiting the Menu, press SETUP while the menu is displayed. The menu display disappears.



Inputting characters

On this unit, you can change the name displayed on the following screens to the names that you prefer.

- Friendly Name (🔍 p. 103)
- Character input for the network functions (🔍 p. 40)

Using the number buttons

- 1 Display the screen for inputting characters.**
 - To change a character, use \triangleleft \triangleright to align the cursor with the character that you want to change.
- 2 Press +10 to select the character type (upper case, lower case, or numeric characters).**

- 3 Press 0 – 9, +10 until the desired character is displayed.**
 - The types of characters that can be input are as shown below.

1 . /	1 . @ - _ / :	6 MNO	m n o M N O 6
2 ABC	a b c A B C 2	7 PQRS	p q r s P Q R S 7
3 DEF	d e f D E F 3	8 TUV	t u v T U V 8
4 GHI	g h i G H I 4	9 WXYZ	w x y z W X Y Z 9
5 JKL	j k l J K L 5	0 []	0 (Space) ! " # \$ % & ' () * + , ; < = > ? [\] ^ ` { }

- 4 Repeat steps 2 and 3 to change the name then press ENTER to register it.**



Using the cursor buttons

1 Display the screen for inputting characters.

- To change a character, use <◀▶> to align the cursor with the character that you want to change.

2 Use Δ∇ to change the character.

- The types of characters that can be input are as shown below.

[Lower case]	abcdefghijklmnopqrstuvwxyz
[Upper case]	ABCDEFGHIJKLMNOPQRSTUVWXYZ
[Symbols]	! " # \$ % & ' () * + , - . / : ; < = > ? @ [\] ^ _ ` { } ~
[Numbers]	0123456789 (Space)

3 Repeat step 2 to change the name then press ENTER to register it.



- Press CLEAR to delete the character.
- Press ▶▶I to insert a space.



General

Make various other settings.

Alarm

Set the once alarm and everyday alarm.

■ Once

Once Alarm Setting:	Set the once alarm to on.
Off:	The alarm does not operate.

■ Every Day

Every Day:	Set the everyday alarm to on.
Off:	The alarm does not operate.

■ Edit Alarm

Edit the once alarm and everyday alarm.

- 1** Use $\Delta \nabla$ to select the alarm mode, then press ENTER.
- 2** Use $\Delta \nabla$ to setting for the alarm start time, then press ENTER.
- 3** Use $\Delta \nabla$ to select the input source, then press ENTER.
 - When “Bluetooth” is selected, this unit attempts to connect to the previously connected device.
- 4** Use $\Delta \nabla$ to select the volume level “00 – 60”, then press ENTER.

The display shows “Complete!!” and the setting is completed.

- The power indicator lights orange when the unit is switched to standby mode in this state.



Clock

■ Set the current time

You can automatically adjust the clock of this unit using the Internet.



- To use this function, the unit must be connected to the Internet.

1 Use Δ / ∇ to select your time zone, then press ENTER.

2 Use Δ / ∇ to select the summer time, then press ENTER.

On: Set the summer time to on.

Off
(Default): Set the summer time to off.

Clock Mode

The clock is constantly displayed.

On:

Display the clock.
Press the POWER \downarrow button to switch between the clock display and the normal display.

Off
(Default):

Does not display the clock.

NOTE

- When "Clock Mode" is set to "On", the unit consumes more standby power.



Volume Limit

■ Make a setting for maximum volume

Limits the volume to ensure safe use of this product, and also makes it easier to adjust the volume from AirPlay or an app to an ideal range.

30 / 45 / 60(Full throttle) / Other (Default : 30)

When “Other” is selected, the volume upper limit can be set within the range of 16 - 60. Select the value using Δ / ∇ and then press ENTER to enter the setting value.



When the maximum volume is set, if you increase the volume to the setting value and press VOLUME▲ again, “Allow max volume?” is displayed. If you press VOLUME▲ again the maximum volume limit is canceled.

CD Auto Play

When the CD tray is closed, the unit can detect the CD, automatically switch the input source to CD and start playback of the disc.

On (Default):	Performs automatic playback.
Off:	Does not perform automatic playback.

Speaker Configuration

You can set up the Bi-Amp function, speakers to use, and the properties of speakers.

■ Bi-Amp

You can use the Speaker A/B terminals to output audio from speakers compatible with Bi-Amp drive.

Enable :	The Bi-Amp function is enabled.
Disable (Default) :	The Bi-Amp function is disabled. You can switch between Speaker A and B.



■ Response

Set the output frequency characteristics.

Flat (Default) :	Properties are flat.
Response1 :	Cuts low frequencies 40 Hz or under by –12 dB/oct.
Response2 :	Cuts low frequencies 60 Hz or under by –12 dB/oct.
Response3 :	Cuts low frequencies 80 Hz or under by –12 dB/oct.
Response4 :	Cuts low frequencies 100 Hz or under by –12 dB/oct.



- “Response” setting values are not reflected in headphone out, Audio out or subwoofer out.

Illumination

Changes/turns off the Front panel illumination color.

White / Blue / Green / Orange / Off



Audio Out

You can set whether to “Fixed” or “Variable” the analog audio output level.

Fixed	Fixes the analog audio output level.
Variable (Default):	You can adjust the analog audio output level using the VOLUME ▲▼ buttons on the remote control. The analog audio output volume is linked to the Speaker A volume.



- When “Variable” is set, the analog audio output volume is linked to the Speaker A volume. The analog audio output volume is not adjusted when the Speaker B volume is adjusted. (🔗 p. 86)

NOTE

- Note that the analog audio output level changes to the maximum when the analog audio output setting is changed from “Variable” to “Fixed”.
- Before changing the settings, turn the volume of the amp connected to the AUDIO OUT connectors and headphones connected to the unit to the minimum volume.

Language

Set the language for display on the menu.

English / Deutsch / Française / Italiano / Nederlands / Español / Svenska / Русский / Polski (Default :English)

Auto-Standby

When “Auto-Standby” is set to “On”, and no operations are made in the stopped state for the set amount of time, this unit automatically enters standby mode.

For the input source “Tuner” and “From iPod” only, when no operation is performed for eight hours, this unit automatically enters the standby mode.

1min / 5min / 15min /	When “Other” is selected, the “Auto-Standby” time can be set within the range of 1 - 99 minutes.
Other (Default : 15min):	Select the value using △▽ and then press ENTER to enter the setting value.
Off:	The unit does not go into standby automatically.



Usage Data

For product improvement purposes, please send information on the device settings and operating conditions of the functions to Marantz. Information provided by customers will be used as reference material for product development purposes in the future.

Marantz will never provide any information we collect to third parties.

Yes:	Provide information on the operating status of this unit.
No:	Do not provide information on the operating status of this unit.

Firmware

Set whether or not to check for firmware update, update the firmware, and display update, upgrade and alert notifications.

■ Update

Update the firmware of this unit.

Check For Update:	Check for firmware updates.
--------------------------	-----------------------------

Update Start:	Execute the update process.
----------------------	-----------------------------



- Even if the update fails, this unit will automatically try to update again.



■ Notifications

Notification messages are displayed in the screen when the power is switched on when new firmware can be used, or when there are other notification messages.

Update

On (Default):	Display update message.
Off:	Do not display update message.

Upgrade

On (Default):	Display upgrade message.
Off:	Do not display upgrade message.

Notification Alerts

On (Default):	Displays notification messages from Marantz in the popup menu.
Off:	Does not display notification messages from Marantz in the popup menu.

■ Add New Feature

Display new features that can be downloaded to this unit and perform an upgrade.

Upgrade package:	Display the items to be upgraded.
Upgrade Status:	Display a list of the additional functions provided by the upgrade.
Upgrade Start:	Execute the upgrade process. When the upgrade starts, the menu screen is shut down. During the upgrade, the amount of upgrade time which has elapsed is displayed.
Upgrade ID:	The ID number shown on the display is needed when carrying out the procedure.



- See the Marantz website for details about upgrades.
- When the procedure is complete, "Registered" is displayed in this menu and upgrades can be carried out. If the procedure has not been carried out, "Not Registered" is displayed.



Notes concerning use of “Update” and “Add New Feature”

- In order to add new functions, the environment and settings required for connecting to broadband internet are needed. (☞ p. 28)
- Perform the add new feature operation after at least 2 minutes has elapsed since turning this unit’s power on.
- Do not turn off the power until updating or upgrading is completed.
- Even with a broadband connection to the Internet, approximately 20 minutes is required for the updating/upgrading procedure to be completed.
- Once updating/upgrade starts, normal operations on this unit cannot be performed until updating/upgrading is completed. Furthermore, updating/upgrading the firmware may reset the backup data for the parameters, etc. set for this unit.
- When the update or upgrade failed with a message such as “Update failed” and “Download failed”, remove and re-insert the power cord. “Update Retry” appears on the display and update restarts from the point at which update failed. If the error continues despite this, check the network environment.



- Information regarding the “Update” function and “Add New Feature” will be announced on the Marantz web site each time related plans are defined.

Reset

Perform this procedure if the display is abnormal or if operations cannot be performed. Various settings are reset to the factory default values. Make settings again.

Cancel: Values are not reset.

Reset factory defaults: Values are reset.



Network

To use this unit by connecting it to a home network (LAN), you must configure network settings. If you set up your home network via DHCP, set “DHCP” to On (use the default setting). This allows this unit to use your home network.

If you assign an IP address for each device, you must use the “IP Address” setting to assign an IP address to this unit and enter the information about your home network such as the gateway address and subnet mask.

Network Information

Display network information.

Friendly Name / DHCP On or Off / IP Address / MAC Address / SSID*

* This is displayed only while a Wi-Fi connection is enabled.

Network Control

Enables network communication in standby power mode.

On: The network function can be used when in standby power mode. Main unit operable with a network compatible controller.

Off (Default): The network function cannot be used in standby power mode.



- When using the Web control function or a network controller or when you want to use Bluetooth/NFC quickly when the power is off, set “Network Control” to “On”.

NOTE

- When “Network Control” is set to “On”, the unit consumes more standby power.



Friendly Name

The Friendly Name is the name of this unit displayed on the network. You can change the Friendly Name according to your preferences.

■ Select Name

Selects Friendly Name from the list.

Current Friendly Name / AV Room / Bedroom / Dining Room / Family Room / Guest Room / Kids Room / Kitchen / Living Room / Office / Marantz M-CR611 / Other (Default :Marantz M-CR611)

- When you select “Other”, you can change the Friendly Name according to your preferences.



- Up to 63 characters can be input.
- For character input, see (🔍 p. 92).

Wi-Fi

You can stop the Wi-Fi function when connecting this unit to the network using Wired LAN.

Enabled (Default):	The Wi-Fi function is used.
Disabled:	The Wi-Fi function is stopped.

Bluetooth

You can stop the Bluetooth function.

Enabled (Default):	The Bluetooth function is used.
Disabled:	The Bluetooth function is stopped.



Settings

You can make detailed settings for the network.

To change the network environment, perform “Quick Setup”. (For details on the operations, see the separate “Quick Setup Guide”).

- If you are using a broadband router (DHCP function), there is no need to make the settings at “IP Address” and “Proxy”, since the DHCP function is set to “On” in this unit’s default settings.
- Only set “Settings” when connecting to a network without a DHCP function.

■ Wired Setup

□ DHCP

Selects how to connect to the network.

On (Default):	Configure the network settings automatically from your router.
Off:	Configure the network settings manually.

□ IP Address

Set the IP address within the ranges shown below.

- The Network Audio function cannot be used if other IP addresses are set.

CLASS A: 10.0.0.1 - 10.255.255.254

CLASS B: 172.16.0.1 - 172.31.255.254

CLASS C: 192.168.0.1 - 192.168.255.254

□ Subnet Mask

When connecting an xDSL modem or connector adapter directly to this unit, input the subnet mask indicated in the documentation supplied by your provider. Normally input 255.255.255.0.

□ Gateway

When connected to a gateway (router), input its IP address.

□ Primary DNS, Secondary DNS

If there is only one DNS address indicated in the documentation supplied by your provider, enter it for “Primary DNS”. If two or more DNS are provided by your provider, enter one for “Secondary DNS”.



Proxy

Make this setting when connecting to the Internet via a proxy server. Make the proxy settings only when you connect to the Internet via a proxy server that is on your internal network or provided by your provider, etc.

Proxy (Off) or Proxy (On):	Set the proxy server.
Proxy (Address) or Proxy (Name):	Select when inputting by address or domain name.
Address or Name:	Inputting address or domain name. Up to 38 characters can be input.
Port:	Enter port number.



- If you cannot connect to the Internet, recheck the connections and settings. (🔗 p. 28)
- If you do not understand about Internet connection, contact your ISP (Internet Service Provider) or the store from which you purchased your computer.

Wi-Fi Setup Method

In this menu, Wi-Fi settings and connections can be made using any of the five connection methods.

Auto-Scan /Share Wi-Fi setting from an iOS device / WPS (Wi-Fi Protected Setup) / Web Browser Setup / Manual



- If a LAN cable is connected, remove it.
- See the “Quick Setup Guide” for details on how to connect to Wi-Fi using the Wi-Fi CONNECT button on the rear panel.



❑ Auto-Scan

This automatically searches for networks.

1 From the list of the networks, select the one you want to connect to.

- Select “Rescan” if the network cannot be found.

2 Make the following settings.

Default Key:	Select the default key. <ul style="list-style-type: none"> • When connecting to a WEP encrypted network, “Default Key” menu is displayed.
Password:	Input the password.
DHCP/Proxy:	Performs the DHCP and proxy setting. (“DHCP” (🔗 p. 104), “Proxy” (🔗 p. 105))
Test Connection:	Test the connection.

❑ Share Wi-Fi setting from an iOS device

You can use an iOS device such as an iPhone or iPad to configure Wi-Fi settings.

After selecting this item, select Settings/Wi-Fi from the iOS device home screen, select “Marantz M-CR611” displayed at the bottom of the screen, and then follow the setting instructions displayed on the iOS device.

For details, see the “Quick Setup Guide”.



- The iOS version must be 7 or later.

❑ WPS (Wi-Fi Protected Setup)

1 Register the PIN code of the unit in the router.



Web Browser Setup

Use a web browser to set up Wi-Fi.

A Wi-Fi device that can perform web browse operations is required.

1 Read the precautions on the screen, and press ENTER.

2 Select “Marantz M-CR611” from the Wi-Fi network list of the Wi-Fi device.

The IP address (192.168.1.16) appears on the unit.

3 Enter the IP address of this unit in browser’s address box.

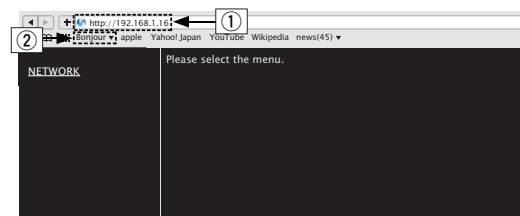

- ① Entering the IP address (192.168.1.16).
- ② If you are using the Safari web browser, you can select “Bonjour” and directly access the unit’s web control screen from the overview section.

4 When the top menu is displayed, click “NETWORK”.

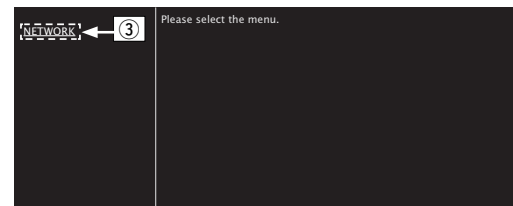

- ③ Click “NETWORK”. (Example 1)



5 Operate.

[Example 1] Network Setting 1

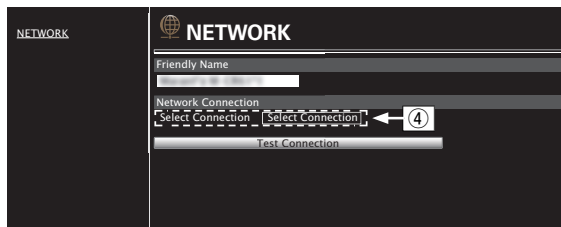

□ Network connection settings

- ④ Click to change the network connection method. If you select “Wi-Fi”, a new item will appear on-screen.
 (👉 [Example 2])

[Example 2] Network Setting 2

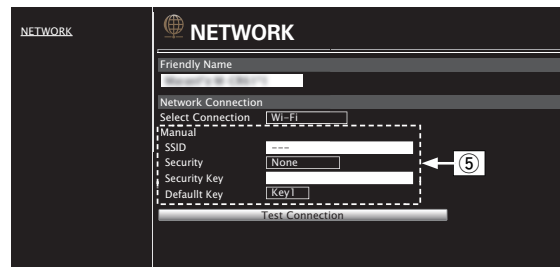

□ Network connection settings

- ⑤ [Example 2] - Displayed when “Wi-Fi” is selected in ④. Select or input items as necessary, and then click “Test Connection” to apply the changes.
- Items displayed may vary depending on selected items and connection status.
 - After selecting each item, wait a moment for the display to be updated.
-  To apply network connection settings, click “Test Connection” after making changes.



❑ Manual

Sets the wireless connection manually

SSID :	Input the name of the wireless network (SSID).
Security:	Select the encryption method according to the encryption setting of the access point you are using.
Default Key:	Select the Default Key. <ul style="list-style-type: none">• When connecting to a “WEP” encrypted network, “Default Key” menu is displayed.
Password:	Input the password.
DHCP/Proxy:	Performs the DHCP and proxy setting. (“DHCP” (👉 p. 104), “Proxy” (👉 p. 105))
Test Connection:	Test the connection.



DAB

Making the DAB settings.

Making the DAB settings

■ Tuning Aid

The reception intensity of the currently tuned in frequency is displayed. Use this if your preferred station cannot be received.

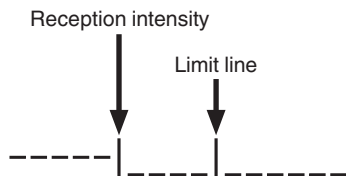

- 1 Use ◀ and ▶ to select a frequency to tune into. It takes around 4-5 seconds to correctly display the reception intensity (-I) after selecting a frequency.
- 2 If necessary, adjust the position of the antenna so that the reception intensity (-I) passes to the right of the limit line (I). The station can now be received.
- 3 Press ENTER to select the station and exit Tuning Aid.

■ Station Order

The service list is created with the auto scan function.

Multiplex: In order of frequency.

Alphanumeric: In alphabetical order.

■ DRC (Dynamic Range Control)

Compress dynamic range (difference between loud and soft sounds).

Off / 1/2 / 1

■ DAB Initialize

When the “DAB Initialize” procedure is performed, all the preset memory settings for the stations and DABs are reset.

■ DAB Version

The DAB module’s version is displayed.



■ Contents

Tips

Simple operations in the power off state	112
Simple operations for iPod/USB	112
I only want to recharge my iPod	112
Specifying the iPod track with the alarm function	112
Specifying the desired track with the alarm function	112
Change to summer time	112
Changing or resetting the network environment	113
Volume adjustment is difficult when using AirPlay or app operation, and the sound suddenly becomes too loud	113
I want to set the optimized listening environment after changing the configuration/position of the speakers or changing a speaker to a new one	113

Troubleshooting

Power does not turn on / Power is turned off	114
LED is flashing	114
Operations cannot be performed through the remote control unit	115
Display on this unit shows nothing	115
No sound comes out	116
Desired sound does not come out	117
Sound is interrupted or noise occurs	118
Cannot playback CDs	119
iPod cannot be played back	120
USB memory devices cannot be played back	121
Bluetooth cannot be played back	122
File names on the iPod/USB memory device are not displayed properly	123
The Internet radio cannot be played back	124
Music files on PC or NAS cannot be played back	125
Cannot connect by Wi-Fi	126



Tips

Simple operations in the power off state

- When a input source select buttons, ►/|| button, FAVORITES CALL button or ▲ button is pressed, the operation is performed at the same time as the unit switches on. (“Basic operation” (🔍 p. 33), “Playing CDs” (🔍 p. 35), “Favorite function” (🔍 p. 53))
- When the “Network Control” is set to “On”, you can perform playback, or other operations through AirPlay, “Marantz Hi-Fi Remote”. (🔍 p. 102)

Simple operations for iPod/USB

- When connected to the Front USB port, the Input Source automatically changes and playback begins. (“Listening to music on an iPod” (🔍 p. 56), “Playing files stored on USB memory devices” (🔍 p. 60))

I only want to recharge my iPod

- Connect the iPod to this unit when the unit power is on. Then turn the unit power off, and the iPod will continue to charge until fully charged. (🔍 p. 58)
- When connected to the Rear USB port, the iPod can be charged without the current Input Source changing.

Specifying the iPod track with the alarm function

- Connect the iPod to this unit by USB and then press the MODE button to register your favorite tracks in the favorites using “On-Display” mode. (🔍 p. 53) Then set a track registered in the favorites as the alarm. (🔍 p. 94)
- When using alarm playback on an iPod touch or iPhone, set the iPod touch or iPhone to “Sleep” mode. If the power is switched off using the power off operation, alarm playback cannot be used.

Specifying the desired track with the alarm function

- After registering the desired track in NAS, etc., register the track in the favorites and then specify the track in the alarm settings. (🔍 p. 94)

Change to summer time

- Select “General” - “Clock” in the setup menu and configure the settings. (🔍 p. 95)



Changing or resetting the network environment

- Prepare the provided “Quick Setup Guide”, and run Setup – “Quick Setup”. For detailed settings, run Setup - “Network” - Settings. (👉 p.104)

Volume adjustment is difficult when using AirPlay or app operation, and the sound suddenly becomes too loud

- Reducing the “Volume Limit” setting value (to around 20 to 30) limits the volume setting from AirPlay or an app to an ideal range and makes it easier to adjust the volume. (👉 p.96)

I want to set the optimized listening environment after changing the configuration/position of the speakers or changing a speaker to a new one

- Select Setup – “General” – “Speaker Configuration” – “Response” and configure the settings. (👉 p.96)



Troubleshooting

1. Are the connections correct?
2. Is the set being operated as described in the owner's manual?
3. Are the other devices operating properly?

If this unit does not operate properly, check the items listed in the table below.

Should the problem persist, there may be a malfunction. In this case, disconnect the power immediately and contact your store of purchase.

■ Power does not turn on / Power is turned off

Symptom	Cause / Solution	Page
Power does not turn on.	<ul style="list-style-type: none"> • Check whether the power plug is correctly inserted into the power outlet. 	31
Power automatically turns off.	<ul style="list-style-type: none"> • The sleep timer is set. Turn on the power again. 	83
	<ul style="list-style-type: none"> • "Auto-Standby" is set. "Auto-Standby" is triggered when there is no operation for a set amount of time. To disable "Auto-Standby", set "Auto-Standby" on the menu to "Off". 	98

■ LED is flashing

Symptom	Cause / Solution	Page
Flashing red.	<ul style="list-style-type: none"> • The amplifier circuit in the unit has malfunctioned. Disconnect the power and contact the repair center. 	—
	<ul style="list-style-type: none"> • The clock is incorrect because the AC was temporarily switched off, etc. Check the network connection and adjust the clock. 	95



■ Operations cannot be performed through the remote control unit

Symptom	Cause / Solution	Page
Operations cannot be performed through the remote control unit.	• Batteries are worn out. Replace with new batteries.	<u>7</u>
	• Operate the remote control unit within a distance of about 7 m from this unit and at an angle of within 30°.	<u>7</u>
	• Remove any obstacle between this unit and the remote control unit.	—
	• Insert the batteries in the proper direction, checking the ⊕ and ⊖ marks.	<u>7</u>
	• The set's remote control sensor is exposed to strong light (direct sunlight, inverter type fluorescent bulb light, etc.). Move the set to a place in which the remote control sensor will not be exposed to strong light.	—
	• When using a 3D video device, the remote control unit of this unit may not function due to effects of infrared communications between units (such as TV and glasses for 3D viewing). In this case, adjust the direction of units with the 3D communications function and their distance to ensure they do not affect operations from the remote control unit of this unit.	—

■ Display on this unit shows nothing

Symptom	Cause / Solution	Page
Display is off.	• Press the DIMMER button on the remote control to set any setting other than OFF.	<u>84</u>



■ No sound comes out

Symptom	Cause / Solution	Page
No sound comes out of speakers.	• Check the connections for all devices.	18
	• Insert connection cables all the way in.	—
	• Check that input connectors and output connectors are not reversely connected.	—
	• Check cables for damage.	—
	• Check that speaker cables are properly connected. Check that cable core wires come in contact with the metal part on speaker terminals. Also, securely tighten speaker terminals. Check speaker terminals for looseness.	18
	• Check that a proper input source is selected.	33
	• Adjust the volume.	34
	• Cancel the mute mode.	34
	• Check that the correct input source is selected when audio is being input to this unit from an external device.	67
	• Check the digital audio output setting on the connected device. The initial settings may be off depending on the device.	67
	• Only 2-channel linear PCM can be input as the digital audio signal to the DIGITAL IN connector of this unit.	67
• Only Speaker A or Speaker B may be selected. Check that the speakers are connected correctly, and press the SPEAKER A/B button to confirm.	85	
• No sound is output from the speakers when headphones are connected.	11	



■ Desired sound does not come out

Symptom	Cause / Solution	Page
Left/right volume balance is unbalanced.	<ul style="list-style-type: none"> Press the DBB/TONE button on the remote control to adjust the balance. 	<u>82</u>
No sound from the sub woofer.	<ul style="list-style-type: none"> Check the subwoofer connections. 	<u>19</u>
	<ul style="list-style-type: none"> Switch the subwoofer power on. 	—
Set values are not reflected in “Dynamic Bass Boost”, “Bass” and “Treble”.	<ul style="list-style-type: none"> “Dynamic Bass Boost”, “Bass” and “Treble” setting values are not reflected in subwoofer out. 	<u>82</u>



■ Sound is interrupted or noise occurs

Symptom	Cause / Solution	Page
During playback from the Internet radio or USB memory device, sound is occasionally interrupted.	• When the transfer speed of the USB memory device is slow, sound may occasionally be interrupted.	—
	• The network communication speed is slow or the radio station is busy.	—
When making a call on iPhone, noise occurs in audio output on this unit.	• When making a call, keep a distance of 20 cm or longer between iPhone and this unit.	—
Noise often occurs in DAB/FM broadcasting.	• Change the antenna orientation or position.	<u>27</u>
	• Use an outdoor antenna.	<u>27</u>
	• Separate the antenna from other connection cables.	<u>27</u>
Sound cuts out when using Wi-Fi connection.	• If nearby devices cause playback to cut out due to electronic interference, switch to a wired LAN connection.	<u>28</u>
	• Particularly when you play back large music files, depending on your wireless LAN environment, the playback sound may be interrupted. In this case, make the wired LAN connection.	<u>104</u>





■ Cannot playback CDs

Symptom	Cause / Solution	Page
Cannot playback when the ►/ button is pressed, or cannot correctly play back a specific part of the disc.	<ul style="list-style-type: none"> The disc is dirty or scratched. Either clean the disc, or insert a different disc. 	133
Cannot playback CD-R/CD-RW.	<ul style="list-style-type: none"> CDs cannot be played back unless they have been finalized. Use a finalized disc. 	133
	<ul style="list-style-type: none"> This may be caused by poor recording conditions, or the disc itself may be of poor quality. Use a correctly recorded disc. 	—
	<ul style="list-style-type: none"> The DATA CD playback function of this unit only supports playback of MP3 and WMA files. 	127
“Unsupported” is displayed.	<ul style="list-style-type: none"> “Unsupported” is displayed if a disc that cannot be played is loaded. 	133
“No Disc” is displayed.	<ul style="list-style-type: none"> “No Disc” is displayed if the disc is loaded upside-down or if no disc is loaded. 	133



■ iPod cannot be played back

Symptom	Cause / Solution	Page
iPod cannot be connected.	• When using iPod by connecting it to the USB port, some iPod variations are not supported.	26
	• When iPod is connected by using a USB cable other than the genuine cable, iPod may not be recognized. Use a genuine USB cable.	—
The AirPlay icon  is not displayed on iTunes / iPhone / iPod touch / iPad.	• This unit and PC / iPhone / iPod touch / iPad are not connected to the same network (LAN). Connect it to the same LAN as this unit.	28
	• The firmware on iTunes / iPhone / iPod touch / iPad is not compatible with AirPlay. Update the firmware to the latest version.	—
No sound is produced.	• The volume on iTunes / iPhone / iPod touch / iPad is set to the minimum level. The volume on iTunes / iPhone / iPod touch / iPad is linked with the volume on this unit. Set a proper volume level.	—
	• The AirPlay playback is not performed, or this unit is not selected. Click the AirPlay icon  on the iTunes / iPhone / iPod touch / iPad screen and select this unit.	68
Audio is interrupted during the AirPlay playback on iPhone / iPod touch / iPad.	• Quit the application running in the background of the iPhone/iPod touch/iPad, and then play using AirPlay.	—
	• Some external factors may be affecting the wireless connection. Modify the network environment by taking measures such as shortening the distance from the wireless LAN access point.	—



■ USB memory devices cannot be played back

Symptom	Cause / Solution	Page
"No Connection" is displayed.	• The set cannot recognize a USB memory device. Disconnect and reconnect the USB memory device.	25
	• USB memory devices of a mass storage class or those compatible with MTP are supported.	—
	• This unit does not support a connection through a USB hub. Connect the USB memory device directly to the USB port.	—
	• The USB memory device must be formatted to FAT16 or FAT32.	—
	• Not all USB memory devices are guaranteed to work. Some USB memory devices are not recognized. When using a type of portable hard disc drive compatible with the USB connection that requires power from an AC adapter, use the AC adapter that came with the drive.	—
Files on the USB memory device are not displayed.	• Files of a type not supported by this unit are not displayed.	59
	• This unit can display a file structure with up to 8 levels and up to 5000 subfolders and files in total. Modify the folder structure of the USB memory device.	—
	• When multiple partitions exist on the USB memory device, only files on the first partition are displayed.	—
Files on a USB memory device cannot be played.	• Files are created in a format that is not supported by this unit. Check the formats supported by this unit.	59
	• You are attempting to play a file that is copyright protected. Files that are copyright protected cannot be played on this unit.	—



■ Bluetooth cannot be played back

Symptom	Cause / Solution	Page
Bluetooth devices cannot be connected to this unit.	• The Bluetooth function in the Bluetooth device has not been enabled. See the Owner's Manual of the Bluetooth device to enable the Bluetooth function.	—
	• Bring the Bluetooth device near to this unit.	—
	• The Bluetooth device cannot connect with this unit if it is not compatible with the A2DP profile.	—
	• Turn the power of the Bluetooth device off and on again, and then try again.	—
	• Set "Network Control" to "On" and connect again.	102
NFC connection fails	• Check the NFC settings on each Bluetooth device.	—
	• Cancel the Lock function on each Bluetooth device.	—
	• Check the NFC position on each Bluetooth device, and then move the NFC close to  on this unit.	66
	• Set "Network Control" to "On" and connect again.	102
The sound is cut off.	• Bring the Bluetooth device near to this unit.	—
	• Remove obstructions between the Bluetooth device and this unit.	—
	• To prevent electromagnetic interference, locate this unit away from microwave ovens, wireless LAN devices and other Bluetooth devices.	—
	• Reconnect the Bluetooth device.	—



■ File names on the iPod/USB memory device are not displayed properly

Symptom	Cause / Solution	Page
The file names are not displayed properly (“...”, etc.).	<ul style="list-style-type: none">Characters that cannot be displayed are used. This is not a malfunction. On this unit, characters that cannot be displayed are replaced with a “.” (period).	—



■ The Internet radio cannot be played back

Symptom	Cause / Solution	Page
The radio station list is not displayed.	<ul style="list-style-type: none"> The LAN cable is not properly connected, or the network is disconnected. Check the connection status. 	<u>28</u>
Internet Radio cannot be played.	<ul style="list-style-type: none"> The selected radio station is broadcasting in a format that is not supported by this unit. Formats that can be played back in this unit are MP3, WMA and AAC. 	<u>130</u>
	<ul style="list-style-type: none"> The firewall function is enabled on the router. Check the firewall setting. 	—
	<ul style="list-style-type: none"> The IP address is not properly set. 	<u>104</u>
	<ul style="list-style-type: none"> Check the power of the router is on. 	—
	<ul style="list-style-type: none"> To obtain the IP address automatically, enable the DHCP server function on the router. Also, set the “DHCP” setting to “On” on this unit. 	<u>104</u>
	<ul style="list-style-type: none"> To obtain the IP address manually, set the IP address and proxy on this unit. 	<u>104</u>
	<ul style="list-style-type: none"> Some radio stations broadcast silently during some time period. In this case, no audio is output. Wait for a while and select the same radio station, or select another radio station. 	<u>40</u>
Cannot connect to favorite radio stations.	<ul style="list-style-type: none"> Radio station is not currently in service. Register radio stations in service. 	—
For some radio stations, “Connection Down” is displayed and station cannot be connected to.	<ul style="list-style-type: none"> The selected radio station is not in service. Select a radio station in service. 	—



■ Music files on PC or NAS cannot be played back

Symptom	Cause / Solution	Page
Files stored on a computer cannot be played.	• Files are stored in a non-compatible format. Record in a compatible format.	131
	• You are attempting to play a file that is copyright protected. Files that are copyright protected cannot be played on this unit.	—
	• The set's USB port cannot be used for connection to a computer.	—
	• Media sharing settings are not correct. Change media sharing settings so that the unit can access the folders on your computer.	44
Server is not found, or it is not possible to connect to the server.	• The computer's or router's firewall is activated. Check the computer's or router's firewall settings.	—
	• Computer's power is not turned on. Turn on the power.	—
	• Server is not running. Launch the server.	—
	• Set's IP address is wrong. Check the set's IP address.	102
Music files on PC cannot be played back.	• Even if PC is connected to the USB port on this unit, music files on it cannot be played back. Connect PC to this unit through the network.	28
Files on PC or NAS are not displayed.	• Files of a type not supported by this unit are not displayed.	131
Music stored on a NAS cannot be played.	• If you use a NAS in conformity with the DLNA standard, enable the DLNA server function in the NAS setting.	—
	• If you use a NAS that does not conform with the DLNA standard, play the music via a PC. Set Windows Media Player's media sharing function and add NAS to the selected play folder.	44
	• If connection is restricted, set audio equipment as the connection target.	—



■ Cannot connect by Wi-Fi

Symptom	Cause / Solution	Page
Cannot connect to the network.	<ul style="list-style-type: none"> The network name and password (WEP, etc.) settings are wrong. Configure the network settings according to the setting details of this unit. 	108
	<ul style="list-style-type: none"> Reduce the distance between the wireless LAN access point and this unit, remove any obstructions and make sure the view to the access point is unobstructed before trying to connect again. Also, install microwave ovens and other network access points as far away as possible. 	—
	<ul style="list-style-type: none"> Check the router power supply. 	—
	<ul style="list-style-type: none"> This unit supports IEEE802.11.b/g/n. 	—
	<ul style="list-style-type: none"> Configure the access point channel settings away from channels that are being used by other networks. 	—
	<ul style="list-style-type: none"> This unit is not compatible with WEP (TSN). 	—
Cannot connect to WPS.	<ul style="list-style-type: none"> Check that the WPS mode of the router is operating. 	—
	<ul style="list-style-type: none"> Press and hold the Wi-Fi CONNECT button (WPS) on this unit for approx. 3 seconds within 2 minutes of operating the router. 	—
	<ul style="list-style-type: none"> A router/settings that are compatible with WPS 2.0 standards are required. Set the encryption time to “None”, “WPA-PSK (AES)” or “WPA2-PSK (AES)”. 	104
	<ul style="list-style-type: none"> If the router encryption method is WEP/WPA-TKIP/WPA2-TKIP, you cannot connect by using the Wi-Fi CONNECT/WPS button. In this case, use the “Auto-Scan” or “Manual” method to connect. 	109
Cannot connect to the network using iPhone/iPod touch/iPad.	<ul style="list-style-type: none"> Update the iPhone/iPod touch/iPad firmware to the latest version. 	—
	<ul style="list-style-type: none"> When using a USB cable to configure the settings, the iOS device firmware version needs to support iOS 5 or later. When configuring the settings via a wireless connection, iOS 7 or later needs to be supported. 	—



Playing back DATA CDs

■ DATA CDs formats

CD-R and CD-RW discs created in the format described below can be played.

Writing software format

ISO9660 level 1

When written in other formats, it may not be possible to play the disc properly.

Maximum number of playable files and folders

Total number of folders and files : 512

Number of folders : 256

File format

MPEG-1 Audio Layer-3

WMA (Windows Media Audio)

Tag data

ID3-Tag (Ver. 1.x and 2.x)

META-Tag (Compatible with title, artist and album names)

■ Compatible formats

	Sampling frequency	Bit rate	Extension
MP3	32/44.1/48 kHz	32 – 320 kbps	.mp3
WMA	32/44.1/48 kHz	64 – 192 kbps	.wma



- Be sure to give files the extension “.MP3” or “.WMA”. Files with any other extensions or files with no extensions cannot be played.
- Mac OS X files assigned with filenames that begin with “_” are not music data and cannot be played back.
- In accordance with copyright laws, recordings you have made should only be used for your personal enjoyment and may not be used in other ways without permission of the copyright holder.



Playing back USB memory devices

- This unit is compatible with MP3 ID3-Tag (Ver. 2) standard.
- This unit is compatible with WMA META tags.
- If the image size of an album artwork exceeds 600 kB, then music may not be played back properly.

Compatible formats

	Sampling frequency	Bit rate	Bit length	Extension
WMA*1	32/44.1/48 kHz	48 – 192 kbps	–	.wma
MP3	32/44.1/48 kHz	32 – 320 kbps	–	.mp3
WAV	32/44.1/48/ 88.2/96/176.4/ 192 kHz	–	16/24 bits	.wav
MPEG-4 AAC*2	32/44.1/48 kHz	16 – 320 kbps	–	.aac/ .m4a/ .mp4
FLAC	32/44.1/48/ 88.2/96/176.4/ 192 kHz	–	16/24 bits	.flac
ALAC*3	32/44.1/48/ 88.2/96kHz	–	16/24 bits	.m4a
AIFF	32/44.1/48/ 88.2/96/176.4/ 192 kHz	–	16/24 bits	.aif/ .aiff
DSD (2-channel)	2.8 MHz	–	1 bit	.dsf/ .dff



- *1 Copyright-protected files can be played on certain portable players compatible with MTP.
- *2 Only files that are not protected by copyright can be played on this unit. Content downloaded from pay sites on the Internet are copyright protected. Also, files encoded in WMA format when ripped from a CD, etc. on a computer may be copyright protected, depending on the computer's settings.
- *3 Copyright [2012] [D&M Holdings. Inc.] Licensed under the Apache License, Version 2.0 (the "License"); you may not use this file except in compliance with the License. You may obtain a copy of the License at <http://www.apache.org/licenses/LICENSE-2.0>

■ Maximum Number of Playable Files and Folder

The limits on the number of folders and files that can be displayed by this unit are as follows.

Media	USB memory device
Item	
Memory capacity	FAT16 : 2 GB, FAT32 : 2 TB
Number of folder directory levels *1	8 levels
Number of folders	500
Number of files*2	5000

*1 The limited number includes the root folder.

*2 The allowable number of files may differ according to the USB memory device capacity and the file size.



Playing back Internet Radio

■ Playable broadcast station specifications

	Sampling frequency	Bit rate	Extension
WMA	32/44.1/48 kHz	48 – 192 kbps	.wma
MP3	32/44.1/48 kHz	32 – 320 kbps	.mp3
MPEG-4 AAC	32/44.1/48 kHz	16 – 320 kbps	.aac/ .m4a/ .mp4

Playing back Bluetooth devices

This unit supports the following Bluetooth profiles.

- A2DP (Advanced Audio Distribution Profile) :
When a Bluetooth device that supports this specification is connected, you can perform high quality streaming distribution of monaural and stereo audio data.
- AVRCP (Audio/Video Remote Control Profile) :
When a Bluetooth device that supports this specification is connected, you can operate the Bluetooth device from this unit.

Bluetooth communications

The radio waves broadcast from this unit may interfere with operations on medical equipment. The radio wave interference may cause a malfunction. Therefore, make sure to turn off power to this unit and Bluetooth devices in the following places.

- Hospitals, trains, airplanes, gas stands, and other places where flammable gas may occur.
- Places near automatic doors and fire alarms.



Playing back files stored on PC or NAS

- This unit is compatible with MP3 ID3-Tag (Ver. 2) standard.
- This unit is compatible with WMA META tags.
- If the image size of an album artwork exceeds 600 kB, then music may not be played back properly.
- A server or server software compatible with distribution in the corresponding formats is required to play music files via a network.



- Particularly when you play back large music files, depending on your wireless LAN environment, the playback sound may be interrupted. In this case, make the wired LAN connection.

■ Playback file specifications

	Sampling frequency	Bit rate	Bit length	Extension
WMA	32/44.1/48 kHz	48 – 192 kbps	–	.wma
MP3	32/44.1/48 kHz	32 – 320 kbps	–	.mp3
WAV	32/44.1/48/ 88.2/96/176.4/ 192 kHz	–	16/24 bits	.wav
MPEG-4 AAC*1	32/44.1/48 kHz	16 – 320 kbps	–	.aac/ .m4a/ .mp4
FLAC	32/44.1/48/ 88.2/96/176.4/ 192 kHz	–	16/24 bits	.flac
ALAC*2	32/44.1/48/ 88.2/96kHz	–	16/24 bits	.m4a
AIFF	32/44.1/48/ 88.2/96/176.4/ 192 kHz	–	16/24 bits	.aif/ .aiff
DSD (2-channel)	2.8 MHz	–	1 bit	.dsf/ .dff



- *1 Only files that are not protected by copyright can be played on this unit.
Content downloaded from pay sites on the Internet are copyright protected.
Also, files encoded in WMA format when ripped from a CD, etc. on a computer may be copyright protected, depending on the computer's settings.
- *2 Copyright [2012] [D&M Holdings. Inc.] Licensed under the Apache License, Version 2.0 (the "License"); you may not use this file except in compliance with the License. You may obtain a copy of the License at <http://www.apache.org/licenses/LICENSE-2.0>



About Discs

Discs playable on this unit

1 Music CDs

Discs marked with the logo below can be played in this unit.



2 CD-R/CD-RW

NOTE

- Discs in special shapes (heart-shaped discs, octagonal discs, etc.) cannot be played. Do not attempt to play them, as doing so can damage the unit.
- Some discs and some recording formats cannot be played.
- Non-finalized discs cannot be played.
- If the unit is left in a room full of smoke from cigarettes, etc., for long periods of time, the surface of the optical pickup may get dirty, preventing it from receiving signals properly.



Loading discs

- Place the disc in the tray, label side up.
- Make sure the disc tray is fully open when inserting the disc.
- Place the discs flat, 12 cm discs in the outer tray guide, 8 cm discs in the inner tray guide.
- Place 8 cm discs in the inner tray guide without using an adapter.



- “Unsupported” is displayed if a disc that cannot be played is loaded.
- “No Disc” is displayed if the disc is loaded upside-down or if no disc is loaded.

NOTE

- Do not push the disc tray in by hand when the power is turned off. Doing so could damage the set.
- Do not place any foreign objects in the disc tray. Doing so could damage the set.
- If the unit is left in a room full of smoke from cigarettes, etc., for long periods of time, the surface of the optical pickup may get dirty, preventing it from receiving signals properly.



■ Cautions on loading discs

- Only load one disc at a time. Loading two or more discs can damage the unit or scratch the discs.
- Do not use cracked or warped discs or discs that have been repaired with adhesive, etc.
- Do not use discs on which the sticky part of cellophane tape or labels is exposed or on which there are traces of where labels have been removed. Such discs can get caught inside the player and damage it.

■ Cautions on handling

- Do not get fingerprints, oil or dirt on discs.
- Take special care not to scratch discs when removing them from their cases.
- Do not bend or heat discs.
- Do not enlarge the hole in the center.
- Do not write on the labeled (printed) surface with ball-point pens, pencils, etc., or stick new labels on discs.
- Water droplets may form on discs if they are moved suddenly from a cold place (outdoors for example) to a warm place, but do not try to dry them off using a hairdryer, etc.

■ Cautions on storing discs

- Be sure to remove discs after using them.
- Be sure to store discs in their cases to protect them from dust, scratches, warping, etc.
- Do not store discs in the following places:
 1. Places exposed to direct sunlight for long periods of time
 2. Dusty or humid places
 3. Places exposed to heat from heaters, etc.

■ Cleaning discs

- If there are fingerprints or dirt on a disc, wipe them off before using the disc. Fingerprints and dirt can impair sound quality and cause interruptions in playback.
- Use a commercially available disc cleaning set or a soft cloth to clean discs.



Gently wipe the disc from the inside towards the outside.

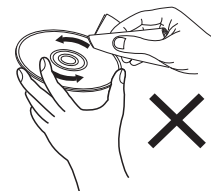

Do not wipe with a circular motion.

NOTE

- Do not use record spray, antistatic agents, benzene, thinner or other solvents.



Last function memory

This stores the settings as they were immediately before going into the standby mode.

When the power is turned back on, the settings are restored to as they were immediately before going into the standby mode.



Explanation of terms

■ Audio

ALAC (Apple Lossless Audio Codec)

This is a codec for lossless audio compression method developed by Apple Inc. This codec can be played back on iTunes, iPod or iPhone. Data compressed to approximately 60 – 70% can be decompressed to exactly the same original data.

AIFF (Audio Interchange File Format)

This is an uncompressed and lossless format for digital audio. Use AIFF files to burn high-quality audio CDs from imported songs. AIFF files use approximately 10 MB of disk space per minute.

DSD (Direct-Stream Digital)

One of the audio data recording methods, it is the signal aspect used to store audio signals on a super audio CD, and is Δ - Σ modulated digital audio. It is configured of an array of single bit values at a 2.8224 MHz sampling rate.

FLAC

FLAC stands for Free lossless Audio Codec, and is a lossless free audio file format. Lossless means that the audio is compressed without any loss in quality.

The FLAC license is as shown below.

Copyright (C) 2000, 2001, 2002, 2003, 2004, 2005, 2006, 2007, 2008, 2009 Josh Coalson

Redistribution and use in source and binary forms, with or without modification, are permitted provided that the following conditions are met:

- Redistributions of source code must retain the above copyright notice, this list of conditions and the following disclaimer.
- Redistributions in binary form must reproduce the above copyright notice, this list of conditions and the following disclaimer in the documentation and/or other materials provided with the distribution.
- Neither the name of the Xiph.org Foundation nor the names of its contributors may be used to endorse or promote products derived from this software without specific prior written permission.



THIS SOFTWARE IS PROVIDED BY THE COPYRIGHT HOLDERS AND CONTRIBUTORS "AS IS" AND ANY EXPRESS OR IMPLIED WARRANTIES, INCLUDING, BUT NOT LIMITED TO, THE IMPLIED WARRANTIES OF MERCHANTABILITY AND FITNESS FOR A PARTICULAR PURPOSE ARE DISCLAIMED. IN NO EVENT SHALL THE FOUNDATION OR CONTRIBUTORS BE LIABLE FOR ANY DIRECT, INDIRECT, INCIDENTAL, SPECIAL, EXEMPLARY, OR CONSEQUENTIAL DAMAGES (INCLUDING, BUT NOT LIMITED TO, PROCUREMENT OF SUBSTITUTE GOODS OR SERVICES; LOSS OF USE, DATA, OR PROFITS; OR BUSINESS INTERRUPTION) HOWEVER CAUSED AND ON ANY THEORY OF LIABILITY, WHETHER IN CONTRACT, STRICT LIABILITY, OR TORT (INCLUDING NEGLIGENCE OR OTHERWISE) ARISING IN ANY WAY OUT OF THE USE OF THIS SOFTWARE, EVEN IF ADVISED OF THE POSSIBILITY OF SUCH DAMAGE.

MP3 (MPEG Audio Layer-3)

This is an internationally standardized audio data compression scheme, using the "MPEG-1" video compression standard. It compresses the data volume to about one eleventh its original size while maintaining sound quality equivalent to a music CD.

MPEG (Moving Picture Experts Group), MPEG-2, MPEG-4

These are the names for digital compression format standards used for the encoding of video and audio. Video standards include "MPEG-1 Video", "MPEG-2 Video", "MPEG-4 Visual", "MPEG-4 AVC". Audio standards include "MPEG-1 Audio", "MPEG-2 Audio", "MPEG-4 AAC".

WMA (Windows Media Audio)

This is audio compression technology developed by Microsoft Corporation.

WMA data can be encoded using Windows Media® Player. To encode WMA files, only use applications authorized by Microsoft Corporation. If you use an unauthorized application, the file may not work properly.



Sampling frequency

Sampling involves taking a reading of a sound wave (analog signal) at regular intervals and expressing the height of the wave at each reading in digitized format (producing a digital signal).

The number of readings taken in one second is called the “sampling frequency”. The larger the value, the closer the reproduced sound is to the original.

Speaker impedance

This is an AC resistance value, indicated in Ω (Ohms). Greater power can be obtained when this value is smaller.

Bit rate

This expresses the read amount per 1 second of video/audio data recorded. A larger number means higher sound quality, but also means a larger file size.

■ Network**AirPlay**

AirPlay sends (plays) contents recorded in iTunes or on an iPhone/iPod touch/iPad to a compatible device via the network.

DLNA

DLNA and DLNA CERTIFIED are trademarks and/or service marks of Digital Living Network Alliance. Some contents may not be compatible with other DLNA CERTIFIED® products.



vTuner

This is a free online content server for Internet Radio. For inquiries about this service, visit the vTuner site below.

vTuner website:

<http://www.radiomarantz.com>

This product is protected by certain intellectual property rights of Nothing Else Matters Software and BridgeCo. Use or distribution of such technology outside of this product is prohibited without a license from Nothing Else Matters Software and BridgeCo or an authorized subsidiary.

WEP Key (network key)

This is key information used for encrypting data when conducting data transfer. On this unit, the same WEP key is used for data encryption and decryption, so the same WEP key must be set on both devices in order for communications to be established between them.

Wi-Fi®

Wi-Fi Certification assures tested and proven interoperability by the Wi-Fi Alliance, a group certifying interoperability among wireless LAN devices.

WPA (Wi-Fi Protected Access)

This is a security standard established by the Wi-Fi Alliance. In addition to the conventional SSID (network name) and WEP key (network key), it also uses a user identification function and encrypting protocol for stronger security.

WPA2 (Wi-Fi Protected Access 2)

This is a new version of the WPA established by the Wi-Fi Alliance, compatible with more secure AES encryption.

WPA-PSK/WPA2-PSK (Pre-shared Key)

This is a simple authentication system for mutual authentication when a preset character string matches on the wireless LAN access point and client.

WPS (Wi-Fi Protected Setup)

This is a standard drawn up by the Wi-Fi Alliance to ease the task of setting up wireless LAN connections and configuring security.

Network Names (SSID: Service Set Identifier)

When forming wireless LAN networks, groups are formed to prevent interference, data theft, etc. These groups are based on "SSID (network names)". For enhanced security, a WEP key is set so that communication is unavailable unless both the "SSID" and the WEP key match. This is suitable for constructing a simplified network.



■ Others

Finalizing

Finalization is the process that makes recorded CD-R/CD-RW discs playable on compatible players

Pairing

Pairing (registration) is an operation that is required in order to connect a Bluetooth device to this unit using Bluetooth. When paired, the devices authenticate each other and can connect without mistaken connections occurring.

When using Bluetooth connection for the first time, you need to pair this unit and the Bluetooth device to be connected.

Protection circuit

This is a function to prevent damage to devices within the power supply when an abnormality such as an overload, excess voltage occurs or over temperature for any reason.



Trademark information



"Made for iPod" and "Made for iPhone" mean that an electronic accessory has been designed to connect specifically to iPod, or iPhone, respectively, and has been certified by the developer to meet Apple performance standards.

Apple is not responsible for the operation of this device or its compliance with safety and regulatory standards. Please note that the use of this accessory with iPod, or iPhone, may affect wireless performance.

AirPlay, iPad, iPhone, iPod, iPod classic, iPod nano and iPod touch are trademarks of Apple Inc., registered in the U.S. and other countries.

- Individual users are permitted to use iPhone, iPod, iPod classic, iPod nano and iPod touch for private copy and playback of non-copyrighted contents and contents whose copy and playback is permitted by law. Copyright infringement is prohibited by law.



The N Mark is a trademark or registered trademark of NFC Forum, Inc. in the United States and in other countries.



The Bluetooth® word mark and logos are registered trademarks owned by Bluetooth SIG, Inc. and any use of such marks by D&M Holdings Inc. is under license. Other trademarks and trade names are those of their respective owners.



The Wi-Fi CERTIFIED logo is a registered trademark of the Wi-Fi Alliance.

Wi-Fi Certification provides assurance that the device has passed the interoperability test conducted by the Wi-Fi Alliance, a group that certifies interoperability among wireless LAN devices.

Adobe, the Adobe logo and Reader are either registered trademarks or trademarks of Adobe Systems Incorporated in the United States and/or other countries.



Specifications

■ Audio section

- CD player

Playable frequency response:	10 Hz - 20 kHz
Wow & flutter:	Below measurable limits (± 0.001 %)
Sampling frequency:	44.1 kHz

- Audio amplifier

Rated output:	2-channel driving 50 W + 50 W (6 Ω /ohms, 1 kHz, THD+N 0.7 %)
Dynamic power:	60 W + 60 W (6 Ω /ohms, 1 kHz, THD+N 10 %)
Output terminals:	Speaker: 4-16 Ω /ohms (impedance) Compatible with headphones/stereo headphones
Input sensitivity/impedance:	Analog In: 200 mV/22 k Ω /kohms
Total harmonic distortion (1 kHz, 5 W, 6 Ω/ohms):	Analog In: 0.1 %
S/N ratio (10 W, 6 Ω/ohms, IHF-A):	Analog In : 90 dB
Tone control:	Dynamic Bass Boost : +8 dB (100 Hz) Bass : ± 10 dB (100 Hz) Treble : ± 10 dB (10 kHz)
Frequency response:	Analog In : 5 Hz – 40 kHz (± 3 dB)



■ Tuner section

Receiving Range:	87.50 MHz – 108.00 MHz
Effective sensitivity:	1.2 μ V / 75 Ω /ohms
FM Channel separation:	42 dB (1 kHz)
FM S/N ratio:	Monaural : 70 dB Stereo : 70 dB

■ DAB tuner section

Receiving Range:	174.928 (5A) – 239.200 (13F) MHz (BAND III)
Sensitivity:	-85 dBm
S/N ratio:	95 dB



■ Wireless LAN section

Network type (wireless LAN standard):	Conforming to IEEE 802.11b Conforming to IEEE 802.11g Conforming to IEEE 802.11n (Wi-Fi® compliant)*1
Security:	WEP 64 bit, WEP 128 bit WPA/WPA2-PSK (AES) WPA/WPA2-PSK (TKIP)
Radio frequency:	2.4 GHz
No. of channels:	1 – 13 ch

*1 The Wi-Fi® CERTIFIED Logo and the Wi-Fi CERTIFIED On-Product Logo are registered trademarks of the Wi-Fi Alliance.



■ Bluetooth section

Communications system:	Bluetooth Version 2.1 + EDR (Enhanced Data Rate)
Transmission power:	Maximum 2.5 mW (Class 2)
Maximum communication range:	Approx. 10 m in line of sight*2
Frequency band:	2.4 GHz band
Modulation scheme:	FHSS (Frequency-Hopping Spread Spectrum)
Supported profiles:	A2DP (Advanced Audio Distribution Profile) 1.2 AVRCP (Audio Video Remote Control Profile) 1.4
Corresponding codec:	SBC, AAC
Transmission range (A2DP):	20 Hz - 20,000 Hz

*2 The actual communication range varies depending on the influence of such factors as obstructions between devices, electromagnetic waves from microwave ovens, static electricity, cordless phones, reception sensitivity, antenna performance, operating system, application software etc.



■ Clock/Alarm/Sleep

Clock type:	Power line frequency synchronized method (Within ± 60 seconds per month)
Alarm:	Once alarm/Everyday alarm: One system each
Sleep:	Sleep timer: Max. 90 minutes

■ General

Power supply:	AC 220 - 230 V, 50/60 Hz
Power consumption:	55 W
Power consumption in standby mode :	0.3 W
Power consumption in “Clock Mode” – “On” mode:	1 W
Power consumption in “Network Control” – “On” mode:	3 W

- For purposes of improvement, specifications and design are subject to change without notice.



■ Dimensions

Unit : mm

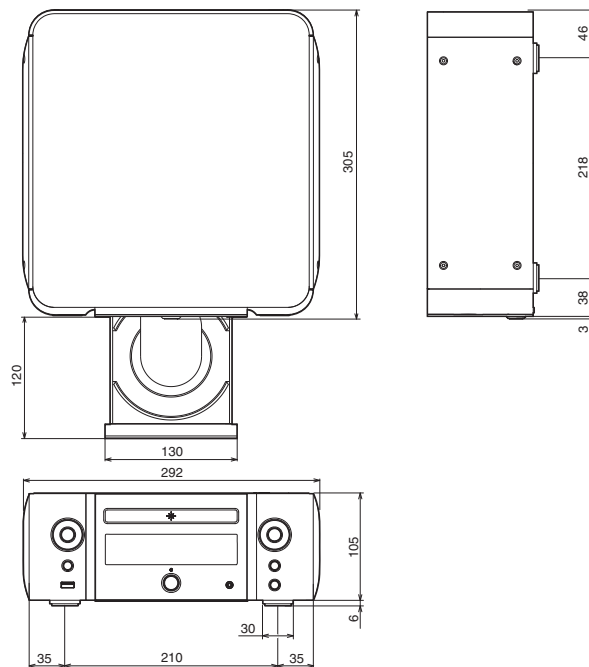

■ Weight : 3.4 kg

Index

A		F		P	
AirPlay	68	Favorites	53	PC	43, 131
Alarm	94	Firmware update	99		
B		Front panel	9	R	
Bluetooth device	61	I		Random playback	45, 60
C		Inputting characters	92	Rear panel	12
CDs	35	Internet Radio	39	Remote control unit	14
D		iPod	25, 55, 58	Remote play function	72
DAB/FM broadcasts	47	M		Repeat playback	45, 60
DATA CDs	37	Menu map	87	Resetting factory settings	101
Display's brightness	84	Muting	34	S	
DLNA	136	N		Sleep timer	83
		NAS	43, 131	Spotify	71
		Network settings	102	T	
				Tone	82
				U	
				USB memory device	25, 59



**V**

Volume	34, 86
vTuner	42

**W**

Web control function	75
Wired LAN	28



License

**This section describes software license used for this unit.
To maintain the correct content, the original (English) is used.**

■ Boost

<http://www.boost.org/>

Boost Software License – Version 1.0 – August 17th, 2003

Permission is hereby granted, free of charge, to any person or organization obtaining a copy of the software and accompanying documentation covered by this license (the “Software”) to use, reproduce, display, distribute, execute, and transmit the Software, and to prepare derivative works of the Software, and to permit third-parties to whom the Software is furnished to do so, all subject to the following:

The copyright notices in the Software and this entire statement, including the above license grant, this restriction and the following disclaimer, must be included in all copies of the Software, in whole or in part, and all derivative works of the Software, unless such copies or derivative works are solely in the form of machine-executable object code generated by a source language processor.

THE SOFTWARE IS PROVIDED “AS IS”, WITHOUT WARRANTY OF ANY KIND, EXPRESS OR IMPLIED, INCLUDING BUT NOT LIMITED TO THE WARRANTIES OF MERCHANTABILITY, FITNESS FOR A PARTICULAR PURPOSE, TITLE AND NON-INFRINGEMENT. IN NO EVENT SHALL THE COPYRIGHT HOLDERS OR ANYONE DISTRIBUTING THE SOFTWARE BE LIABLE FOR ANY DAMAGES OR OTHER LIABILITY, WHETHER IN CONTRACT, TORT OR OTHERWISE, ARISING FROM, OUT OF OR IN CONNECTION WITH THE SOFTWARE OR THE USE OR OTHER DEALINGS IN THE SOFTWARE.

■ Expat

<http://www.jclark.com/xml/expat.html>

Expat License. Copyright (c) 1998, 1999, 2000 Thai Open Source Software Center Ltd

Permission is hereby granted, free of charge, to any person obtaining a copy of this software and associated documentation files (the “Software”), to deal in the Software without restriction, including without limitation the rights to use, copy, modify, merge, publish, distribute, sublicense, and/or sell copies of the Software, and to permit persons to whom the Software is furnished to do so, subject to the following conditions:

The above copyright notice and this permission notice shall be included in all copies or substantial portions of the Software.

THE SOFTWARE IS PROVIDED “AS IS”, WITHOUT WARRANTY OF ANY KIND, EXPRESS OR IMPLIED, INCLUDING BUT NOT LIMITED TO THE WARRANTIES OF MERCHANTABILITY, FITNESS FOR A PARTICULAR PURPOSE AND NON-INFRINGEMENT. IN NO EVENT SHALL THE AUTHORS OR COPYRIGHT HOLDERS BE LIABLE FOR ANY CLAIM, DAMAGES OR OTHER LIABILITY, WHETHER IN AN ACTION OF CONTRACT, TORT OR OTHERWISE, ARISING FROM, OUT OF OR IN CONNECTION WITH THE SOFTWARE OR THE USE OR OTHER DEALINGS IN THE SOFTWARE.

■ FastDelegate

<http://www.codeproject.com/KB/cpp/FastDelegate.aspx>

THE WORK (AS DEFINED BELOW) IS PROVIDED UNDER THE TERMS OF THIS CODE PROJECT OPEN LICENSE (“LICENSE”). THE WORK IS PROTECTED BY COPYRIGHT AND/OR OTHER APPLICABLE LAW. ANY USE OF THE WORK OTHER THAN AS AUTHORIZED UNDER THIS LICENSE OR COPYRIGHT LAW IS PROHIBITED.

BY EXERCISING ANY RIGHTS TO THE WORK PROVIDED HEREIN, YOU ACCEPT AND AGREE TO BE BOUND BY THE TERMS OF THIS LICENSE. THE AUTHOR GRANTS YOU THE RIGHTS CONTAINED HEREIN IN CONSIDERATION OF YOUR ACCEPTANCE OF SUCH TERMS AND CONDITIONS. IF YOU DO NOT AGREE TO ACCEPT AND BE BOUND BY THE TERMS OF THIS LICENSE, YOU CANNOT MAKE ANY USE OF THE WORK.



Definitions. “Articles” means, collectively, all articles written by Author which describes how the Source Code and Executable Files for the Work may be used by a user.

“Author” means the individual or entity that offers the Work under the terms of this License.

“Derivative Work” means a work based upon the Work or upon the Work and other pre-existing works.

“Executable Files” refer to the executables, binary files, configuration and any required data files included in the Work.

“Publisher” means the provider of the website, magazine, CD-ROM, DVD or other medium from or by which the Work is obtained by You.

“Source Code” refers to the collection of source code and configuration files used to create the Executable Files.

“Standard Version” refers to such a Work if it has not been modified, or has been modified in accordance with the consent of the Author, such consent being in the full discretion of the Author.

“Work” refers to the collection of files distributed by the Publisher, including the Source Code, Executable Files, binaries, data files, documentation, whitepapers and the Articles.

“You” is you, an individual or entity wishing to use the Work and exercise your rights under this License.

Fair Use/Fair Use Rights. Nothing in this License is intended to reduce, limit, or restrict any rights arising from fair use, fair dealing, first sale or other limitations on the exclusive rights of the copyright owner under copyright law or other applicable laws.

License Grant. Subject to the terms and conditions of this License, the Author hereby grants You a worldwide, royalty-free, non-exclusive, perpetual (for the duration of the applicable copyright) license to exercise the rights in the Work as stated below: You may use the standard version of the Source Code or Executable Files in Your own applications.

You may apply bug fixes, portability fixes and other modifications obtained from the Public Domain or from the Author. A Work modified in such a way shall still be considered the standard version and will be subject to this License.

You may otherwise modify Your copy of this Work (excluding the Articles) in any way to create a Derivative Work, provided that You insert a prominent notice in each changed file stating how, when and where You changed that file.

You may distribute the standard version of the Executable Files and Source Code or Derivative Work in aggregate with other (possibly commercial) programs as part of a larger (possibly commercial) software distribution.

The Articles discussing the Work published in any form by the author may not be distributed or republished without the Author’s consent. The author retains copyright to any such Articles. You may use the Executable Files and Source Code pursuant to this License but you may not repost or republish or otherwise distribute or make available the Articles, without the prior written consent of the Author.

Any subroutines or modules supplied by You and linked into the Source Code or Executable Files this Work shall not be considered part of this Work and will not be subject to the terms of this License.

Patent License. Subject to the terms and conditions of this License, each Author hereby grants to You a perpetual, worldwide, non-exclusive, no-charge, royalty-free, irrevocable (except as stated in this section) patent license to make, have made, use, import, and otherwise transfer the Work.

Restrictions. The license granted in Section 3 above is expressly made subject to and limited by the following restrictions: You agree not to remove any of the original copyright, patent, trademark, and attribution notices and associated disclaimers that may appear in the Source Code or Executable Files.

You agree not to advertise or in any way imply that this Work is a product of Your own.

The name of the Author may not be used to endorse or promote products derived from the Work without the prior written consent of the Author.

You agree not to sell, lease, or rent any part of the Work. This does not restrict you from including the Work or any part of the Work inside a larger software distribution that itself is being sold. The Work by itself, though, cannot be sold, leased or rented.



You may distribute the Executable Files and Source Code only under the terms of this License, and You must include a copy of, or the Uniform Resource Identifier for, this License with every copy of the Executable Files or Source Code You distribute and ensure that anyone receiving such Executable Files and Source Code agrees that the terms of this License apply to such Executable Files and/or Source Code. You may not offer or impose any terms on the Work that alter or restrict the terms of this License or the recipients' exercise of the rights granted hereunder. You may not sublicense the Work. You must keep intact all notices that refer to this License and to the disclaimer of warranties. You may not distribute the Executable Files or Source Code with any technological measures that control access or use of the Work in a manner inconsistent with the terms of this License.

You agree not to use the Work for illegal, immoral or improper purposes, or on pages containing illegal, immoral or improper material. The Work is subject to applicable export laws. You agree to comply with all such laws and regulations that may apply to the Work after Your receipt of the Work.

Representations, Warranties and Disclaimer. THIS WORK IS PROVIDED "AS IS", "WHERE IS" AND "AS AVAILABLE", WITHOUT ANY EXPRESS OR IMPLIED WARRANTIES OR CONDITIONS OR GUARANTEES. YOU, THE USER, ASSUME ALL RISK IN ITS USE, INCLUDING COPYRIGHT INFRINGEMENT, PATENT INFRINGEMENT, SUITABILITY, ETC. AUTHOR EXPRESSLY DISCLAIMS ALL EXPRESS, IMPLIED OR STATUTORY WARRANTIES OR CONDITIONS, INCLUDING WITHOUT LIMITATION, WARRANTIES OR CONDITIONS OF MERCHANTABILITY, MERCHANTABLE QUALITY OR FITNESS FOR A PARTICULAR PURPOSE, OR ANY WARRANTY OF TITLE OR NON-INFRINGEMENT, OR THAT THE WORK (OR ANY PORTION THEREOF) IS CORRECT, USEFUL, BUG-FREE OR FREE OF VIRUSES. YOU MUST PASS THIS DISCLAIMER ON WHENEVER YOU DISTRIBUTE THE WORK OR DERIVATIVE WORKS.

Indemnity. You agree to defend, indemnify and hold harmless the Author and the Publisher from and against any claims, suits, losses, damages, liabilities, costs, and expenses (including reasonable legal or attorneys' fees) resulting from or relating to any use of the Work by You.

Limitation on Liability. EXCEPT TO THE EXTENT REQUIRED BY APPLICABLE LAW, IN NO EVENT WILL THE AUTHOR OR THE PUBLISHER BE LIABLE TO YOU ON ANY LEGAL THEORY FOR ANY SPECIAL, INCIDENTAL, CONSEQUENTIAL, PUNITIVE OR EXEMPLARY DAMAGES ARISING OUT OF THIS LICENSE OR THE USE OF THE WORK OR OTHERWISE, EVEN IF THE AUTHOR OR THE PUBLISHER HAS BEEN ADVISED OF THE POSSIBILITY OF SUCH DAMAGES.

Termination.

This License and the rights granted hereunder will terminate automatically upon any breach by You of any term of this License. Individuals or entities who have received Derivative Works from You under this License, however, will not have their licenses terminated provided such individuals or entities remain in full compliance with those licenses. Sections 1, 2, 6, 7, 8, 9, 10 and 11 will survive any termination of this License.

If You bring a copyright, trademark, patent or any other infringement claim against any contributor over infringements You claim are made by the Work, your License from such contributor to the Work ends automatically.

Subject to the above terms and conditions, this License is perpetual (for the duration of the applicable copyright in the Work). Notwithstanding the above, the Author reserves the right to release the Work under different license terms or to stop distributing the Work at any time; provided, however that any such election will not serve to withdraw this License (or any other license that has been, or is required to be, granted under the terms of this License), and this License will continue in full force and effect unless terminated as stated above.

Publisher. The parties hereby confirm that the Publisher shall not, under any circumstances, be responsible for and shall not have any liability in respect of the subject matter of this License. The Publisher makes no warranty whatsoever in connection with the Work and shall not be liable to You or any party on any legal theory for any damages whatsoever, including without limitation any general, special, incidental or consequential damages arising in connection to this license. The Publisher reserves the right to cease making the Work available to You at any time without notice

Miscellaneous

This License shall be governed by the laws of the location of the head office of the Author or if the Author is an individual, the laws of location of the principal place of residence of the Author.

If any provision of this License is invalid or unenforceable under applicable law, it shall not affect the validity or enforceability of the remainder of the terms of this License, and without further action by the parties to this License, such provision shall be reformed to the minimum extent necessary to make such provision valid and enforceable.



No term or provision of this License shall be deemed waived and no breach consented to unless such waiver or consent shall be in writing and signed by the party to be charged with such waiver or consent.

This License constitutes the entire agreement between the parties with respect to the Work licensed herein. There are no understandings, agreements or representations with respect to the Work not specified herein. The Author shall not be bound by any additional provisions that may appear in any communication from You. This License may not be modified without the mutual written agreement of the Author and You

libogg

<http://www.xiph.org/ogg/>

Copyright (c) 2002, Xiph.org Foundation

Redistribution and use in source and binary forms, with or without modification, are permitted provided that the following conditions are met:

- Redistributions of source code must retain the above copyright notice, this list of conditions and the following disclaimer.
- Redistributions in binary form must reproduce the above copyright notice, this list of conditions and the following disclaimer in the documentation and/or other materials provided with the distribution.
- Neither the name of the Xiph.org Foundation nor the names of its contributors may be used to endorse or promote products derived from this software without specific prior written permission.

THIS SOFTWARE IS PROVIDED BY THE COPYRIGHT HOLDERS AND CONTRIBUTORS "AS IS" AND ANY EXPRESS OR IMPLIED WARRANTIES, INCLUDING, BUT NOT LIMITED TO, THE IMPLIED WARRANTIES OF MERCHANTABILITY AND FITNESS FOR A PARTICULAR PURPOSE ARE DISCLAIMED. IN NO EVENT SHALL THE FOUNDATION OR CONTRIBUTORS BE LIABLE FOR ANY DIRECT, INDIRECT, INCIDENTAL, SPECIAL, EXEMPLARY, OR CONSEQUENTIAL DAMAGES (INCLUDING, BUT NOT LIMITED TO, PROCUREMENT OF SUBSTITUTE GOODS OR SERVICES; LOSS OF USE, DATA, OR PROFITS; OR BUSINESS INTERRUPTION) HOWEVER CAUSED AND ON ANY THEORY OF LIABILITY, WHETHER IN CONTRACT, STRICT LIABILITY, OR TORT (INCLUDING NEGLIGENCE OR OTHERWISE) ARISING IN ANY WAY OUT OF THE USE OF THIS SOFTWARE, EVEN IF ADVISED OF THE POSSIBILITY OF SUCH DAMAGE.

libvorbis

<http://www.xiph.org/vorbis/>

Copyright (c) 2002-2004 Xiph.org Foundation

Redistribution and use in source and binary forms, with or without modification, are permitted provided that the following conditions are met:

- Redistributions of source code must retain the above copyright notice, this list of conditions and the following disclaimer.
- Redistributions in binary form must reproduce the above copyright notice, this list of conditions and the following disclaimer in the documentation and/or other materials provided with the distribution.
- Neither the name of the Xiph.org Foundation nor the names of its contributors may be used to endorse or promote products derived from this software without specific prior written permission.

THIS SOFTWARE IS PROVIDED BY THE COPYRIGHT HOLDERS AND CONTRIBUTORS "AS IS" AND ANY EXPRESS OR IMPLIED WARRANTIES, INCLUDING, BUT NOT LIMITED TO, THE IMPLIED WARRANTIES OF MERCHANTABILITY AND FITNESS FOR A PARTICULAR PURPOSE ARE DISCLAIMED. IN NO EVENT SHALL THE FOUNDATION OR CONTRIBUTORS BE LIABLE FOR ANY DIRECT, INDIRECT, INCIDENTAL, SPECIAL, EXEMPLARY, OR CONSEQUENTIAL DAMAGES (INCLUDING, BUT NOT LIMITED TO, PROCUREMENT OF SUBSTITUTE GOODS OR SERVICES; LOSS OF USE, DATA, OR PROFITS; OR BUSINESS INTERRUPTION) HOWEVER CAUSED AND ON ANY THEORY OF LIABILITY, WHETHER IN CONTRACT, STRICT LIABILITY, OR TORT (INCLUDING NEGLIGENCE OR OTHERWISE) ARISING IN ANY WAY OUT OF THE USE OF THIS SOFTWARE, EVEN IF ADVISED OF THE POSSIBILITY OF SUCH DAMAGE.

Tremolo

<http://wss.co.uk/pinknoise/tremolo>

Copyright (C) 2002 – 2009 Xiph.org Foundation Changes Copyright (C) 2009 – 2010 Robin Watts for Pinknoise Productions Ltd

Redistribution and use in source and binary forms, with or without modification, are permitted provided that the following conditions are met:



- Redistributions of source code must retain the above copyright notice, this list of conditions and the following disclaimer.
- Redistributions in binary form must reproduce the above copyright notice, this list of conditions and the following disclaimer in the documentation and/or other materials provided with the distribution.
- Neither the name of the Xiph.org Foundation nor the names of its contributors may be used to endorse or promote products derived from this software without specific prior written permission.

THIS SOFTWARE IS PROVIDED BY THE COPYRIGHT HOLDERS AND CONTRIBUTORS "AS IS" AND ANY EXPRESS OR IMPLIED WARRANTIES, INCLUDING, BUT NOT LIMITED TO, THE IMPLIED WARRANTIES OF MERCHANTABILITY AND FITNESS FOR A PARTICULAR PURPOSE ARE DISCLAIMED. IN NO EVENT SHALL THE FOUNDATION OR CONTRIBUTORS BE LIABLE FOR ANY DIRECT, INDIRECT, INCIDENTAL, SPECIAL, EXEMPLARY, OR CONSEQUENTIAL DAMAGES (INCLUDING, BUT NOT LIMITED TO, PROCUREMENT OF SUBSTITUTE GOODS OR SERVICES; LOSS OF USE, DATA, OR PROFITS; OR BUSINESS INTERRUPTION) HOWEVER CAUSED AND ON ANY THEORY OF LIABILITY, WHETHER IN CONTRACT, STRICT LIABILITY, OR TORT (INCLUDING NEGLIGENCE OR OTHERWISE) ARISING IN ANY WAY OUT OF THE USE OF THIS SOFTWARE, EVEN IF ADVISED OF THE POSSIBILITY OF SUCH DAMAGE.

■ Tremor

<http://wiki.xiph.org/index.php/Tremor>

Copyright (c) 2002, Xiph.org Foundation

Redistribution and use in source and binary forms, with or without modification, are permitted provided that the following conditions are met:

- Redistributions of source code must retain the above copyright notice, this list of conditions and the following disclaimer.
- Redistributions in binary form must reproduce the above copyright notice, this list of conditions and the following disclaimer in the documentation and/or other materials provided with the distribution.
- Neither the name of the Xiph.org Foundation nor the names of its contributors may be used to endorse or promote products derived from this software without specific prior written permission.

THIS SOFTWARE IS PROVIDED BY THE COPYRIGHT HOLDERS AND CONTRIBUTORS "AS IS" AND ANY EXPRESS OR IMPLIED WARRANTIES, INCLUDING, BUT NOT LIMITED TO, THE IMPLIED WARRANTIES OF MERCHANTABILITY AND FITNESS FOR A PARTICULAR PURPOSE ARE DISCLAIMED. IN NO EVENT SHALL THE FOUNDATION OR CONTRIBUTORS BE LIABLE FOR ANY DIRECT, INDIRECT, INCIDENTAL, SPECIAL, EXEMPLARY, OR CONSEQUENTIAL DAMAGES (INCLUDING, BUT NOT LIMITED TO, PROCUREMENT OF SUBSTITUTE GOODS OR SERVICES; LOSS OF USE, DATA, OR PROFITS; OR BUSINESS INTERRUPTION) HOWEVER CAUSED AND ON ANY THEORY OF LIABILITY, WHETHER IN CONTRACT, STRICT LIABILITY, OR TORT (INCLUDING NEGLIGENCE OR OTHERWISE) ARISING IN ANY WAY OUT OF THE USE OF THIS SOFTWARE, EVEN IF ADVISED OF THE POSSIBILITY OF SUCH DAMAGE.

■ Mersenne Twister

<http://www.math.sci.hiroshima-u.ac.jp/~m-mat/MT/MT2002/CODES/mt19937ar.c>

Copyright (C) 1997 – 2002, Makoto Matsumoto and Takuji Nishimura,

All rights reserved.

Redistribution and use in source and binary forms, with or without modification, are permitted provided that the following conditions are met:

Redistributions of source code must retain the above copyright notice, this list of conditions and the following disclaimer.

Redistributions in binary form must reproduce the above copyright notice, this list of conditions and the following disclaimer in the documentation and/or other materials provided with the distribution.

The names of its contributors may not be used to endorse or promote products derived from this software without specific prior written permission.



THIS SOFTWARE IS PROVIDED BY THE COPYRIGHT HOLDERS AND CONTRIBUTORS "AS IS" AND ANY EXPRESS OR IMPLIED WARRANTIES, INCLUDING, BUT NOT LIMITED TO, THE IMPLIED WARRANTIES OF MERCHANTABILITY AND FITNESS FOR A PARTICULAR PURPOSE ARE DISCLAIMED. IN NO EVENT SHALL THE COPYRIGHT OWNER OR CONTRIBUTORS BE LIABLE FOR ANY DIRECT, INDIRECT, INCIDENTAL, SPECIAL, EXEMPLARY, OR CONSEQUENTIAL DAMAGES (INCLUDING, BUT NOT LIMITED TO, PROCUREMENT OF SUBSTITUTE GOODS OR SERVICES; LOSS OF USE, DATA, OR PROFITS; OR BUSINESS INTERRUPTION) HOWEVER CAUSED AND ON ANY THEORY OF LIABILITY, WHETHER IN CONTRACT, STRICT LIABILITY, OR TORT (INCLUDING NEGLIGENCE OR OTHERWISE) ARISING IN ANY WAY OUT OF THE USE OF THIS SOFTWARE, EVEN IF ADVISED OF THE POSSIBILITY OF SUCH DAMAGE.

■ zlib

<http://www.zlib.net/>

zlib.h -- interface of the "zlib" general purpose compression library version 1.2.3, July 18th, 2005

Copyright (C) 1995 – 2004 Jean-loup Gailly and Mark Adler

This software is provided "as-is", without any express or implied warranty. In no event will the authors be held liable for any damages arising from the use of this software.

Permission is granted to anyone to use this software for any purpose, including commercial applications, and to alter it and redistribute it freely, subject to the following restrictions:

The origin of this software must not be misrepresented; you must not claim that you wrote the original software. If you use this software in a product, an acknowledgment in the product documentation would be appreciated but is not required.

Altered source versions must be plainly marked as such, and must not be misrepresented as being the original software.

This notice may not be removed or altered from any source distribution.

Jean-loup Gailly jloup@gzip.org, Mark Adler madler@alumni.caltech.edu

■ cURL

<http://curl.haxx.se>

COPYRIGHT AND PERMISSION NOTICE

Copyright (c) 1996 – 2011, Daniel Stenberg, <daniel@haxx.se>.

All rights reserved.

Permission to use, copy, modify, and distribute this software for any purpose with or without fee is hereby granted, provided that the above copyright notice and this permission notice appear in all copies.

THE SOFTWARE IS PROVIDED "AS IS", WITHOUT WARRANTY OF ANY KIND, EXPRESS OR IMPLIED, INCLUDING BUT NOT LIMITED TO THE WARRANTIES OF MERCHANTABILITY, FITNESS FOR A PARTICULAR PURPOSE AND NONINFRINGEMENT OF THIRD PARTY RIGHTS. IN NO EVENT SHALL THE AUTHORS OR COPYRIGHT HOLDERS BE LIABLE FOR ANY CLAIM, DAMAGES OR OTHER LIABILITY, WHETHER IN AN ACTION OF CONTRACT, TORT OR OTHERWISE, ARISING FROM, OUT OF OR IN CONNECTION WITH THE SOFTWARE OR THE USE OR OTHER DEALINGS IN THE SOFTWARE.

Except as contained in this notice, the name of a copyright holder shall not be used in advertising or otherwise to promote the sale, use or other dealings in this Software without prior written authorization of the copyright holder.

■ c-ares

<http://c-ares.haxx.se>

Copyright 1998 by the Massachusetts Institute of Technology.

Permission to use, copy, modify, and distribute this software and its documentation for any purpose and without fee is hereby granted, provided that the above copyright notice appear in all copies and that both that copyright notice and this permission notice appear in supporting documentation, and that the name of M.I.T. not be used in advertising or publicity pertaining to distribution of the software without specific, written prior permission. M.I.T. makes no representations about the suitability of this software for any purpose. It is provided "as is" without express or implied warranty.



■ License information for the software used in the unit

About GPL (GNU-General Public License), LGPL (GNU Lesser General Public License) License

This product uses GPL/LGPL software and software made by other companies.

After you purchase this product, you may procure, modify or distribute the source code of the GPL/LGPL software that is used in the product. Marantz provides the source code based on the GPL and LPGL licenses at the actual cost upon your request to our customer service center.

However, note that we make no guarantees concerning the source code.

Please also understand that we do not offer support for the contents of the source code.





www.marantz.com

You can find your nearest authorized distributor or dealer on our website.

marantz[®] is a registered trademark.

3520 10403 00AM

Copyright ©2015 D&M Holdings Inc. All Rights Reserved.