

Quick Start Guide

Mu-so. 2nd Generation.



1

What's in the box

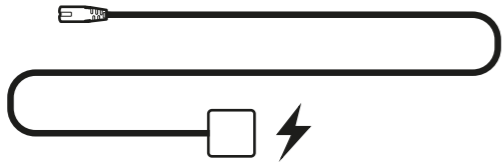
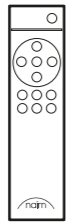
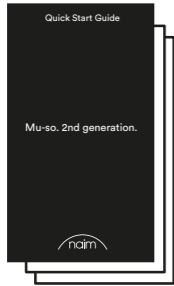
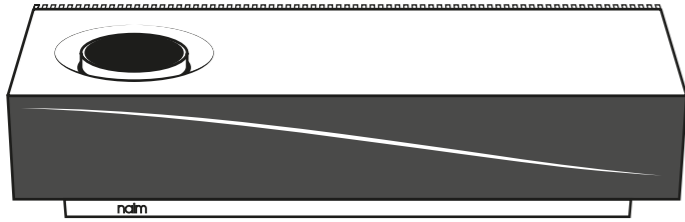

2

Get to know your Mu-so

Front view

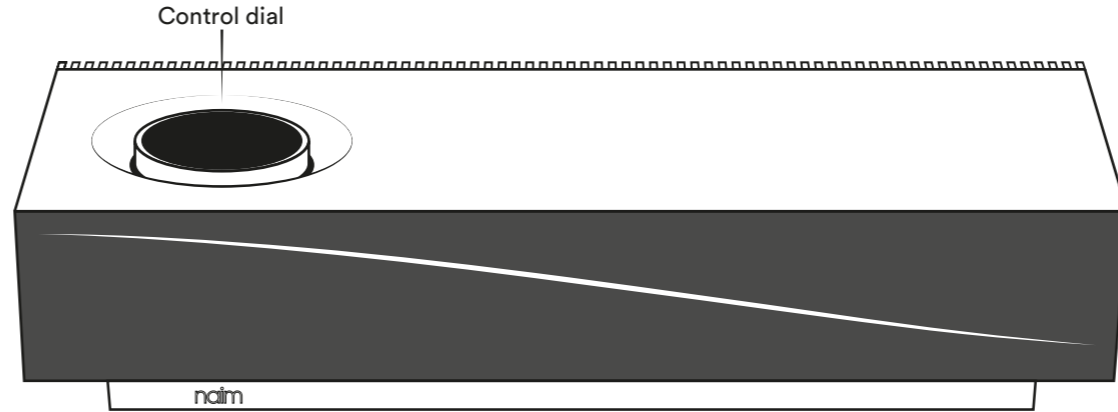

Side view

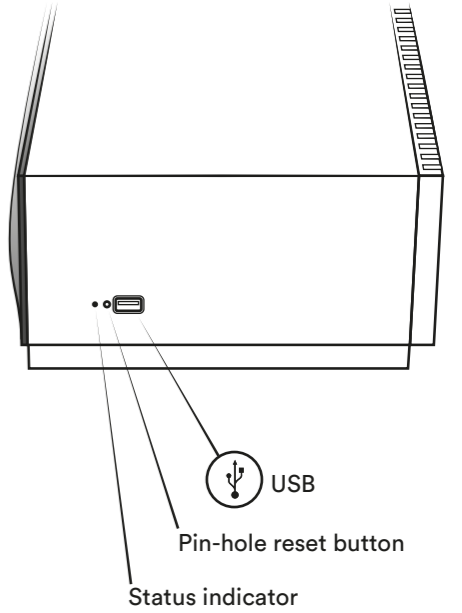

Bottom view

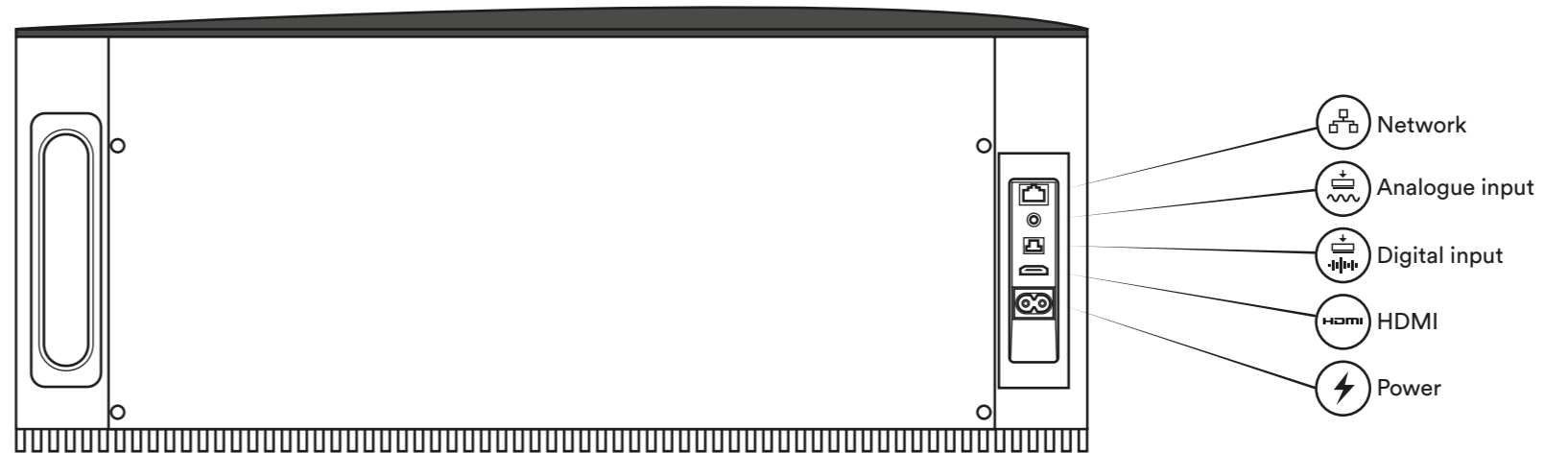

Controls

Proximity control



iRadio favourites or Spotify presets



Wave your hand over the dial to wake the Mu-so

15 touch sensitive buttons

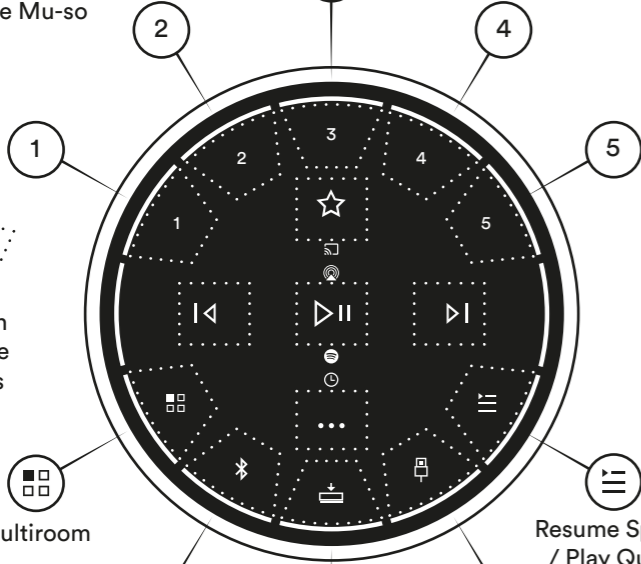
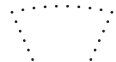

Multiroom

Bluetooth

External inputs

USB

Resume Spotify / Play Queue

Activities selection



Rotate illuminated dial for volume control

Volume indicators



Chromecast



AirPlay



Spotify



Alarm clock

Backlit dial

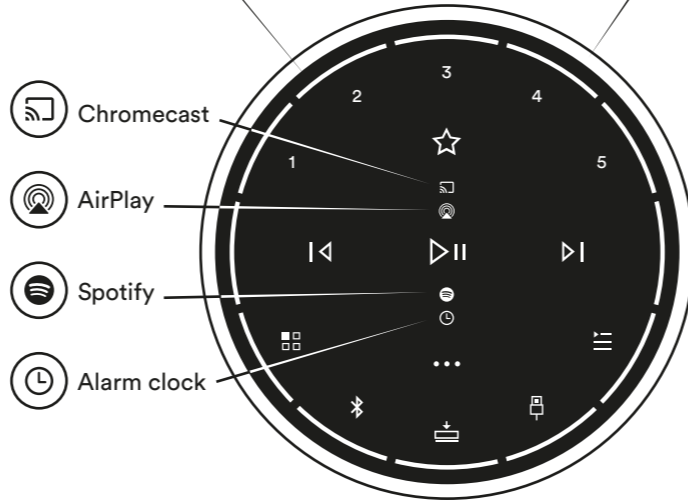

Hold down for 3 seconds to put Mu-so in standby

3

Remote

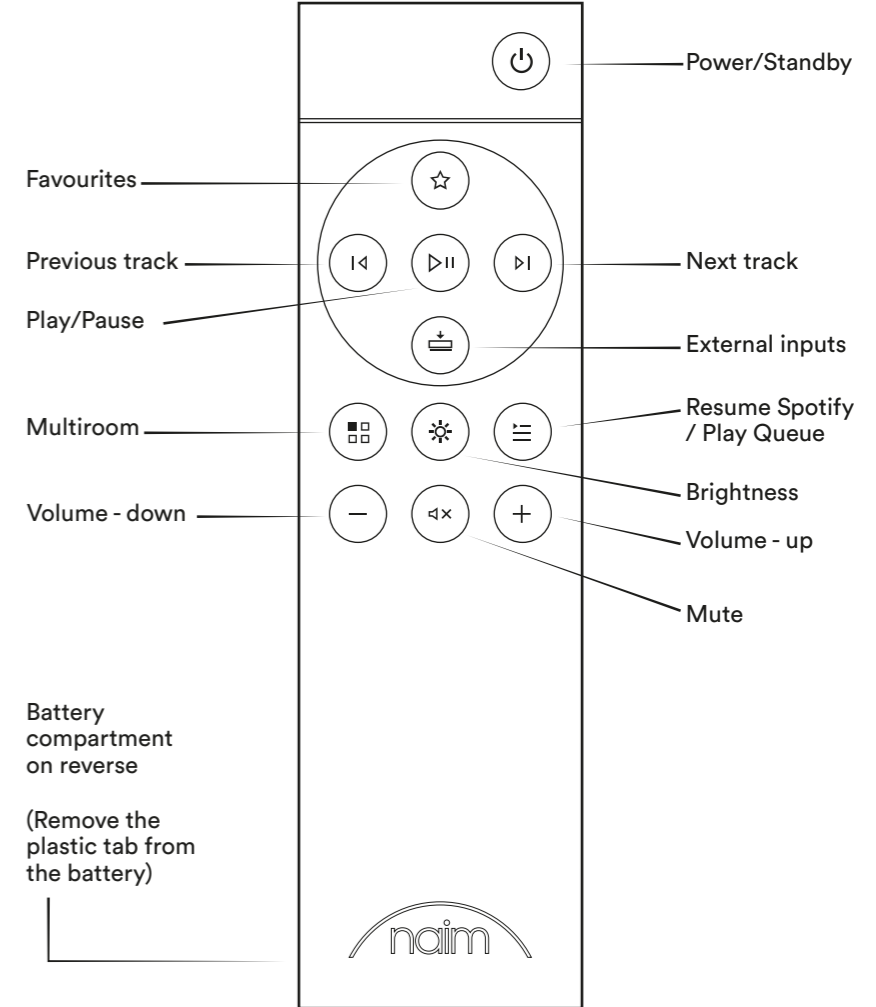

Playing music



Naim App

Use the Naim App to set up and control your **Mu-so**. Look for 'Naim' on the Apple App Store or Google Play Store to download and install. Launch the app and follow the setup instructions to configure your **Mu-so** and learn about its features.



Other ways to listen to your music



Listen out loud with Spotify Connect

(1) Connect your **Mu-so** to your wi-fi network. (2) Open up the Spotify app on your phone, tablet or laptop using the same wi-fi network. (3) Play a song and select Devices Available. (4) Select your **Mu-so** and start listening.



AirPlay

AirPlay is an Apple technology designed to control home audio systems and speakers in any room from your iPhone, iPad, HomePod or Apple TV.



To setup AirPlay 2 use the Home app on an iOS device running software 11.4 or later. Open the Home app and tap the **+** button to add it as an Accessory. You can also enable AirPlay from macOS via the **Mu-so's** webpage by navigating to its IP address in your browser.



Chromecast built-in

Stream your favourite music from your phone, tablet or laptop to your **Mu-so**. To use Chromecast built-in to cast audio to your **Mu-so**, you must first configure it using the Google Home app. You can set up Chromecast groups with other products in the Devices screen.

Lecture de musique



Naim App

Utilisez l'application Naim pour configurer et contrôler votre **Mu-so**. Cherchez « Naim » sur l'Apple App Store ou le Google Play Store, puis téléchargez l'application et installez-la. Lancez l'application et suivez les instructions pour configurer votre **Mu-so** et découvrir ses caractéristiques.

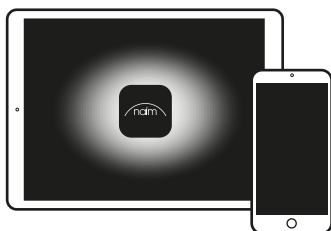

Autres façons d'écouter votre musique



Écoutez fort avec Spotify Connect

(1) Connectez votre **Mu-so** à votre réseau wi-fi. (2) Ouvrez l'application Spotify sur votre téléphone, tablette ou ordinateur portable en utilisant le même réseau wi-fi. (3) Jouez une chanson et sélectionnez Devices Available. (4) Sélectionnez votre **Mu-so** et commencez à écouter.



AirPlay

AirPlay est une technologie Apple conçue pour contrôler les systèmes audio domestiques et les haut-parleurs dans n'importe quelle pièce depuis votre iPhone, iPad, HomePod ou Apple TV.



Pour configurer AirPlay 2, utilisez l'application Home sur un appareil iOS exécutant le logiciel 11.4 ou ultérieur. Ouvrez l'application d'accueil et appuyez sur le bouton **+** pour l'ajouter en tant qu'accessoire. Vous pouvez également activer AirPlay à partir de macOS via la page Web de **Mu-so** en naviguant jusqu'à son adresse IP dans votre navigateur.



Chromecast built-in

Diffusez votre musique préférée de votre téléphone, tablette ou ordinateur portable sur votre **Mu-so**. Pour utiliser Chromecast intégré afin de diffuser de l'audio sur votre **Mu-so**, vous devez d'abord le configurer à l'aide de l'application Google Home. Vous pouvez configurer des groupes Chromecast avec d'autres produits dans l'écran Périphériques.

Musik abspielen



Naim App

Verwenden Sie die Naim-App, um Ihr **Mu-so**-Musiksystem einzurichten und zu steuern. Suchen Sie im Apple App Store oder Google Play Store nach „Naim“, um die App herunterzuladen und zu installieren. Starten Sie die App und folgen Sie den Installationsanweisungen, um Ihre **Mu-so** zu konfigurieren und mehr über wichtige Funktionen zu erfahren.

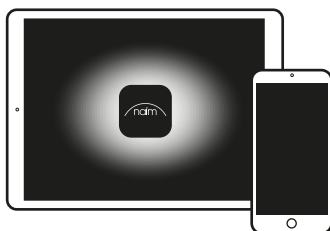

Andere Möglichkeiten, um Ihre Musik zu hören



Hören Sie mit Spotify Connect laut zu

(1) Verbinde dein **Mu-so** mit deinem Wi-Fi-Netzwerk. (2) Öffnen Sie die Spotify-App auf Ihrem Smartphone, Tablet oder Laptop mit demselben Wi-Fi-Netzwerk. (3) Spielen Sie einen Song ab und wählen Sie Verfügbare Geräte. (4) Wähle deine **Mu-so** und höre zu.



AirPlay

AirPlay ist eine Apple-Technologie, die entwickelt wurde, um Heim-Audiosysteme und Lautsprecher in jedem Raum von Ihrem iPhone, iPad, HomePod oder Apple TV aus zu steuern.



Um AirPlay 2 einzurichten, verwenden Sie die Home-App auf einem iOS-Gerät mit Software 11.4 oder höher. Öffne die Home-App und tippe auf die Schaltfläche **+**, um sie als Zubehör hinzuzufügen. Sie können AirPlay von macOS auch über die Webseite von Mu-so aktivieren, indem Sie in Ihrem Browser zu seiner IP-Adresse navigieren.



Chromecast built-in

Streame deine Lieblingsmusik von deinem Handy, Tablet oder Laptop zu deinem **Mu-so**. Wenn Sie Chromecast verwenden möchten, um Audio auf Ihr **Mu-so** zu streamen, müssen Sie es zunächst mit der Google Home-App konfigurieren. Sie können Chromecast-Gruppen mit anderen Produkten auf dem Bildschirm Geräte einrichten.

Muziek afspelen



Naim App

Gebruik de Naim-app om de **Mu-so** in te stellen en te bedienen. Zoek naar 'Naim' in de Apple App Store of Google Play Store om de app te downloaden en te installeren. Start de app en volg de instructies om de **Mu-so** te configureren en meer over de functies aan de weet te komen.

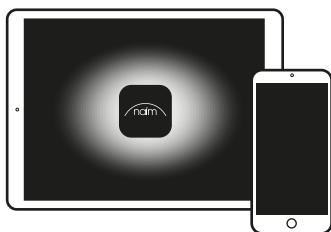

Andere manieren om naar je muziek te luisteren



Luister hardop met Spotify Connect

(1) Verbind je **Mu-so** met je wifi-netwerk. (2) Open de Spotify-app op uw telefoon, tablet of laptop met hetzelfde wifi-netwerk. (3) Speel een nummer af en selecteer Apparaten beschikbaar. (4) Selecteer je **Mu-so** en begin te luisteren.



AirPlay

AirPlay is een Apple-technologie die is ontworpen om thuis audiosystemen en luidsprekers in elke kamer vanaf uw iPhone, iPad, HomePod of Apple TV te bedienen.



Om AirPlay 2 in te stellen, gebruikt u de Home-app op een iOS-apparaat met software 11.4 of later. Open de Home-app en tik op de knop **+** om deze toe te voegen als een accessoire. U kunt AirPlay ook vanaf macOS inschakelen via de **Mu-so**'s-webpagina door naar het IP-adres in uw browser te navigeren.



Chromecast built-in

Stream je favoriete muziek vanaf je telefoon, tablet of laptop naar je **Mu-so**. Als u de ingebouwde Chromecast wilt gebruiken om audio naar uw **Mu-so** te casten, moet u deze eerst configureren met de Google Home-app. U kunt Chromecast-groepen instellen met andere producten in het scherm Apparaten.

Reproducción de música



Naim App

Utilice la aplicación Naim para configurar y controlar su **Mu-so**. Busque «Naim» en la Apple App Store o en la Google Play Store para descargar e instalar la aplicación. Abra la aplicación Naim y siga las instrucciones de configuración para configurar su **Mu-so** y conocer sus funciones.

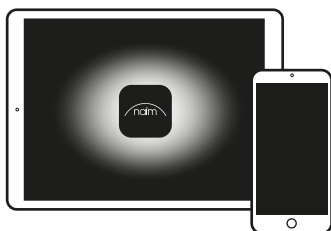

Otras formas de escuchar tu música



Escucha en voz alta con Spotify Connect

(1) Conecte su **Mu-so** a su red wi-fi. (2) Abra la aplicación Spotify en su teléfono, tableta o computadora portátil usando la misma red wi-fi. (3) Reproduzca una canción y seleccione Dispositivos disponibles. (4) Seleccione su **Mu-so** y comience a escuchar.



AirPlay

AirPlay es una tecnología de Apple diseñada para controlar los sistemas de audio para el hogar y los altavoces en cualquier habitación desde su iPhone, iPad, HomePod o Apple TV.



Para configurar AirPlay 2, use la aplicación Home en un dispositivo iOS que ejecute el software 11.4 o posterior. Abra la aplicación Inicio y toque el botón **+** para agregarlo como Accesorio. También puede habilitar AirPlay desde macOS a través de la página web de **Mu-so** navegando hasta su dirección IP en su navegador.



Chromecast built-in

Transmita su música favorita desde su teléfono, tableta o computadora portátil a su **Mu-so**. Para emitir audio a través del Chromecast incorporado en tu **Mu-so**, primero debes configurarlo usando la aplicación Google Home. Puede configurar grupos de Chromecast con otros productos en la pantalla Dispositivos.

Riproduzione musica



Naim App

Usa la App Naim per configurare e controllare il tuo **Mu-so**. Cerca "Naim" su Apple App Store o su Google Play Store per scaricarla e installarla. Avvia la app e segui le istruzioni per configurare il **Mu-so** e conoscerne le funzionalità.

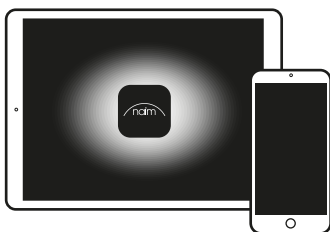

Altri modi per ascoltare la tua musica



Ascolta ad alta voce con Spotify Connect

(1) Connetti il tuo **Mu-so** alla tua rete wi-fi. (2) Aprire l'app Spotify sul telefono, tablet o laptop utilizzando la stessa rete Wi-Fi. (3) Riprodurre un brano e selezionare Dispositivi disponibili. (4) Seleziona il tuo **Mu-so** e inizia ad ascoltare.



AirPlay

AirPlay è una tecnologia Apple progettata per controllare i sistemi audio domestici e gli altoparlanti in qualsiasi stanza da iPhone, iPad, HomePod o Apple TV.



Per configurare AirPlay 2 usa l'app Home su un dispositivo iOS con software 11.4 o successivo. Apri l'app Home e tocca il pulsante **+** per aggiungerla come Accessorio. Puoi anche abilitare AirPlay da macOS tramite la pagina web di Mu-so navigando verso il suo indirizzo IP nel browser.



Chromecast built-in

Trasmetti la tua musica preferita dal tuo telefono, tablet o laptop al tuo **Mu-so**. Per utilizzare la funzione Chromecast per trasmettere l'audio al tuo Mu-so, devi prima configurare **Mu-so** utilizzando l'app Google Home. Puoi configurare i gruppi Chromecast con altri prodotti nella schermata Dispositivi.

Reproduzindo música



Naim App

Utilize a aplicação Naim para configurar e controlar o seu **Mu-so**. Procure "Naim" na Apple App Store ou na Google Play Store para a transferir e instalar. Inicie a aplicação e siga as instruções de configuração para configurar o **Mu-so** e ficar a conhecer as suas funcionalidades.

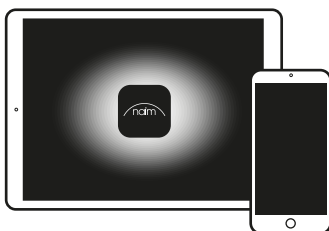

Outras formas de ouvir a sua música



Ouçá música com Spotify Connect

(1) Conecte o **Mu-so** à sua rede wi-fi. (2) Abra a app Spotify no seu telefone, tablet ou laptop usando a mesma rede wi-fi. (3) Escolha uma música e seleccione Dispositivos disponíveis. (4) Seleccione o seu **Mu-so** e comece a ouvir.



AirPlay

O AirPlay é uma tecnologia da Apple projetada para controlar sistemas de áudio domésticos e colunas em qualquer sala do seu iPhone, iPad, HomePod ou Apple TV.



Para configurar o AirPlay 2, use o aplicativo Home num dispositivo iOS com a versão 11.4 ou posterior. Abra a app e na Página inicial toque no botão **+** para adicioná-lo como um acessório. Você também pode habilitar o AirPlay a partir do macOS através da página do **Mu-so**, navegando para o seu endereço IP no navegador de internet.



Chromecast built-in

Transmita a sua música favorita do seu telemóvel, tablet ou portátil diretamente para o seu **Mu-so**. Para usar Chromecast integrado para transmitir áudio para o seu **Mu-so**, deve primeiro configurá-lo usando o aplicativo Google Home. Pode configurar grupos de Chromecast com outros produtos no ecrã "Dispositivos".

Odtwarzanie muzyki



Naim App

Używaj aplikacji Naim, aby sterować urządzeniem **Mu-so**. Znajdź, a następnie pobierz i zainstaluj aplikację Naim z Apple App Store lub Google Play Store. Uruchom aplikację Naim i postępuj zgodnie z instrukcjami, aby skonfigurować **Mu-so** i poznać jego funkcje.

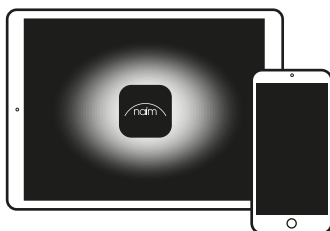

Inne sposoby słuchania muzyki



Słuchaj głośno za pomocą Spotify Connect

(1) Podłącz swój **Mu-so** do sieci Wi-Fi. (2) Otwórz aplikację Spotify na telefonie, tablecie lub laptopie za pomocą tej samej sieci Wi-Fi. (3) Odtwórz utwór i wybierz Urządzenia dostępne. (4) Wybierz swój **Mu-so** i zacznij słuchać.



AirPlay

AirPlay to technologia firmy Apple przeznaczona do sterowania domowymi systemami audio i głośnikami w dowolnym pomieszczeniu z Twojego iPhone'a, iPada, HomePod lub Apple TV.



Aby skonfigurować AirPlay 2, użyj aplikacji domowej na urządzeniu iOS z oprogramowaniem 11.4 lub nowszym. Otwórz aplikację Home i naciśnij przycisk **+**, aby dodać ją jako akcesorium. Możesz również włączyć funkcję AirPlay z systemu Mac OS za pośrednictwem strony **Mu-so**, przechodząc do jej adresu IP w przeglądarce.



Chromecast built-in

Przesyłaj ulubioną muzykę z telefonu, tabletu lub laptopa do urządzenia **Mu-so**. Aby używać Chromecasta do przesyłania dźwięku do **Mu-so**, musisz najpierw skonfigurować go za pomocą aplikacji Google Home. Możesz skonfigurować grupy Chromecasta z innymi produktami na ekranie Urządzenia.

Воспроизведение музыки



Naim App

Используйте приложение Naim для настройки и управления вашей системой **Mu-so**. Для загрузки и установки приложения введите 'Naim' в строке поиска Apple App Store или Google Play Store. Запустите приложение, ознакомьтесь с функциями вашей системы **Mu-so** и следуйте инструкциям для ее настройки.

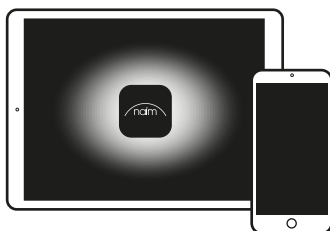

Другие способы прослушивания музыки



Слушайте громко с помощью **Spotify Connect**

(1) Подключите свой **Mu-so** к вашей сети wi-fi. (2) Откройте приложение Spotify на своем телефоне, планшете или ноутбуке, используя ту же сеть wi-fi. (3) Воспроизведите песню и выберите Устройства. (4) Выберите свой **Mu-so** и начните слушать.



AirPlay

AirPlay - это технология Apple, предназначенная для управления домашними аудиосистемами и динамиками в любой комнате с вашего iPhone, iPad, HomePod или Apple TV.



Для настройки AirPlay 2 используйте приложение «Домой» на устройстве iOS с программным обеспечением 11.4 или новее. Откройте приложение «Домой» и нажмите кнопку **+**, чтобы добавить его в качестве аксессуара. Вы также можете включить AirPlay из macOS через веб-страницу **Mu-so**, перейдя по своему IP-адресу в вашем браузере.



Chromecast built-in

Поток вашей любимой музыки с вашего телефона, планшета или ноутбука на ваш **Mu-so**. Чтобы использовать встроенный Chromecast для трансляции звука на **Mu-so**, сначала необходимо настроить его с помощью приложения Google Home. Вы можете настроить группы Chromecast на другие продукты на экране «Устройства».

播放音乐



Naim App

用Naim应用程序设置和控制您的**Mu-so**。在Apple App Store或Google Play商店中找到“Naim”进行下载和安装。启动应用程序，并按照设置说明配置您的**Mu-so**以了解其功能。

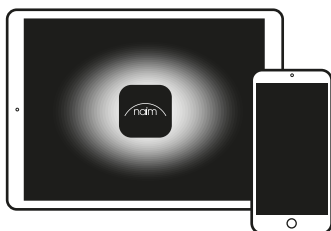

其他听音乐的方式



用**Spotify Connect**大声聆听

(1) 将您的**Mu-so**连接到您的Wi-Fi网络。2) 使用相同的Wi-Fi网络在手机，平板电脑或笔记本电脑上打开Spotify应用程序。(3) 播放歌曲并选择可用设备。(4) 选择您的**Mu-so**并开始聆听。



AirPlay

AirPlay是一项Apple技术，旨在通过iPhone，iPad，HomePod或Apple TV控制任何房间的家庭音响系统和扬声器。



要设置AirPlay 2，请在运行软件11.4或更高版本的iOS设备上使用Home应用程序。打开Home应用程序，然后点击 **+** 按钮将其添加为附件。您还可以通过浏览器中的IP地址，通过**Mu-so**的网页从macOS启用AirPlay。



Chromecast built-in

将您喜爱的音乐从手机，平板电脑或笔记本电脑传输到**Mu-so**。请先使用Google Home App完成设定，然后使用内建的Chromecast传输音源讯号到您的**Mu-so**。您可以在“设备”屏幕中使用其他产品设置Chromecast群组。

播放



Naim 应用

用Naim應用程式設置和控制您的**Mu-so**。在Apple App Store或Google Play商店中找到“Naim”進行下載和安裝。啟動應用程式，並按照設置說明配置您的**Mu-so**以瞭解其功能。

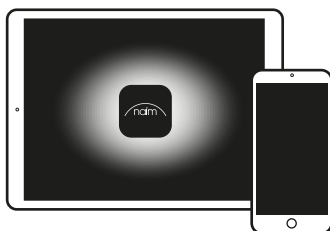

其他聽音樂的方式



用Spotify Connect大聲聆聽

(1) 將您的**Mu-so**連接到您的Wi-Fi網絡。(2) 使用相同的Wi-Fi網絡在手機、平板電腦或筆記本電腦上打開Spotify應用程序。(3) 播放歌曲並選擇可用設備。(4) 選擇您的**Mu-so**並開始聆聽。



AirPlay

AirPlay是一項Apple技術，旨在通過iPhone、iPad、HomePod或Apple TV控制任何房間的家庭音響系統和揚聲器。



要設置AirPlay 2，請在運行軟件11.4或更高版本的iOS設備上使用Home應用程序。打開Home應用程序，然後點擊 **+** 按鈕將其添加為附件。您還可以通過瀏覽器中的IP地址，通過**Mu-so**的網頁從macOS啟用AirPlay。



Chromecast built-in

將您喜愛的音樂從手機、平板電腦或筆記本電腦傳輸到 **Mu-so**。請先使用Google Home App 完成設定，然後使用內建的Chromecast 傳輸音源訊號到您的**Mu-so**。您可以在“設備”屏幕中使用其他產品設置Chromecast群組。

음악 재생



Naim App

Naim 앱을 사용하여 **Mu-so**를 설정 및 제어합니다. **Apple App Store** 또는 **Google Play Store**에서 'Naim' 을 찾아 다운로드 및 설치합니다. 앱을 실행하고 설치 지시에 따라 **Mu-so**를 구성하고 그 기능에 대해 배웁니다.

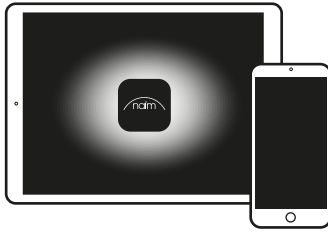

음악을 듣는 다른 방법들



Spotify Connect로 큰 소리로 들으십시오

1) **Mu-so**를 Wi-Fi 네트워크에 연결하십시오. (2) 동일한 Wi-Fi 네트워크를 사용하여 휴대 전화, 태블릿 또는 노트북에서 **Spotify** 앱을 엽니다. (3) 노래를 연주하고 사용 가능한 장치를 선택하십시오. (4) **Mu-so**를 선택하고 듣기를 시작하십시오.



AirPlay

AirPlay는 iPhone, iPad, HomePod 또는 Apple TV에서 모든 객실의 가정용 오디오 시스템 및 스피커를 제어하도록 설계된 **Apple** 기술입니다.



AirPlay 2를 설정하려면 소프트웨어 11.4 이상을 실행하는 iOS 장치에서 홈 응용 프로그램을 사용하십시오. **Home** 앱을 열고 **+** 버튼을 탭하여 액세스리로 추가하십시오. **Mu-so**의 웹 페이지에서 브라우저의 IP 주소로 이동하여 macOS 에서 **AirPlay**를 활성화 할 수도 있습니다.



Chromecast built-in

휴대 전화, 태블릿 또는 노트북에서 좋아하는 음악을 **Mu-so**로 스트리밍하십시오. 내장된 크롬 캐스트(Chromecast)로 음악을 재생하려면, 먼저 구글 홈 앱(Google home app)에서 설정을 해야 합니다. 기기 화면에서 다른 제품으로 **Chromecast** 그룹을 설정할 수 있습니다.

音楽の再生



Naim App

Naimアプリを使って、**Mu-so**の設定とコントロールを行う。Apple App StoreまたはGoogle Playストアで「Naim」を検索し、ダウンロード、インストールする。アプリを起動し、設定ガイドに従って**Mu-so**を構成し、本機の機能を知る。



あなたの音楽を聴く他の方法



Spotify Connect で大声で聴く

1) **Mu-so**をWi-Fiネットワークに接続します。(2) 同じWi-Fiネットワークを使用して、携帯電話、タブレットまたはノートパソコンで**Spotify**アプリを開きます。(3) 曲を再生し、Available Devicesを選択します。(4) あなたの**Mu-so**を選んで聞き始める。



AirPlay

AirPlayは、iPhone、iPad、HomePod、またはApple TVからどの部屋のホームオーディオシステムやスピーカーを制御するために設計されたアップルのテクノロジーです。



AirPlay 2を設定するには、ソフトウェア11.4以降を実行しているiOSデバイスでホームアプリを使用します。ホームアプリを開き、**+** ボタンをタップしてアクセサリとして追加します。**Mu-so**のWebページからブラウザのIPアドレスに移動して、macOSからAirPlayを有効にすることもできます。



Chromecast built-in

スマートフォン、タブレット、ノートパソコンからお気に入りの音楽を**Mu-so**にストリームします。Google Home Appでの設定を完了させてから、内蔵されているChromecastを使用し音楽の信号を**Mu-so**まで送ること。[デバイス]画面で他の製品でChromecastグループを設定できます。

Further help and FAQs

Visit the Naim website for further support,
interactive setup and support guides.

www.naimaudio.com/mu-so-support

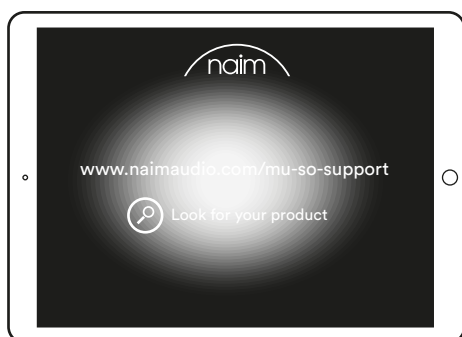

Contact

mu-sosupport@naimaudio.com

Support helpline:

+44 (0) 333 321 9923 (UK)

+1 800 961 5681 (USA and Canada)

Warranties

Peace of mind guaranteed

We are confident your new Mu-so® wireless music system will bring you a deeper connection with music. You will be listening to even more music than ever before, discovering new artists and rediscovering old classics. In the unlikely event that something does go wrong you are covered by a two-year warranty* backed by Naim Audio and our international distributors that is redeemable via your retailer with valid proof of purchase.

*For full terms and conditions visit www.naimaudio.com/mu-so-warranty

Register your new Mu-so

Register your Mu-so with us online to join our vibrant online community of music lovers. You will get exclusive access to the latest Naim news and content from our independent record label.

naimaudio.com/mu-so-registration



Acknowledgements

Mu-so® is a registered trademark of Naim Audio Ltd. Registered in the United Kingdom and other countries.



Use of the Works with Apple badge means that an accessory has been designed to work specifically with the technology identified in the badge and has been certified by the developer to meet Apple performance standards.

Apple, AirPlay, iPad, iPod, iPhone, Apple TV and HomePod are trademarks of Apple Inc., registered in the U.S. and other countries. The trademark "iPhone" is used in Japan with a license from Aiphone K.K.



The Chromecast built-in badge is a trademark of Google Inc.



The Spotify software is subject to third party licences found here: www.spotify.com/connect/third-party-licenses.



UPnP™ is a trademark of the UPnP™ Forum.



The music player for music lovers



The terms HDMI® and HDMI High-Definition Multimedia Interface, and the HDMI Logo are trademarks or registered trademarks of HDMI Licensing LLC in the United States and other countries.



The Bluetooth® word mark and logos are registered trademarks owned by Bluetooth SIG, Inc. and any use of such marks by Naim Audio Ltd. is under licence. Other trademarks and trade names are those of their respective owners.



Wi-Fi® logo is a registered trademark of Wi-Fi Alliance.





Designed by Naim Audio, Salisbury, England
naimaudio.com/mu-so-support