

Pioneer

WIRELESS SPEAKER

MRX-5/MRX-3

Basic Manual

Mode d'Emploi Base

Manual Básico

Manuale di Base

Grund Anleitung

Basis Handleiding

Основное Руководство

БЕСПРОВОДНАЯ АКУСТИЧЕСКАЯ СИСТЕМА

EAC

Setup & Play **with App**

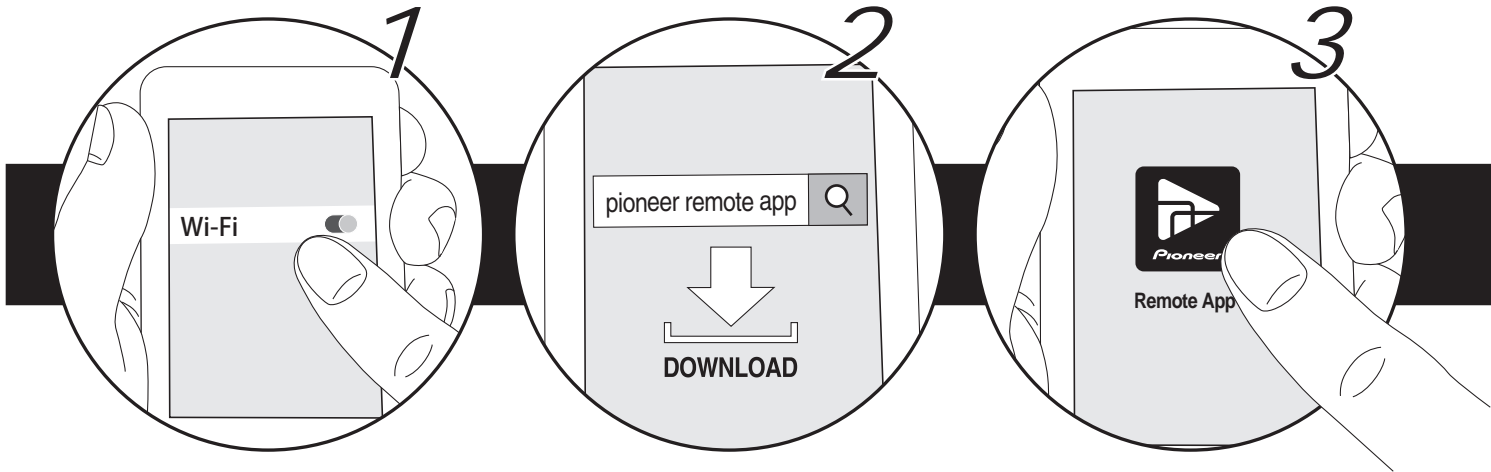

Configuration & Lecture avec l'appli / Configuración y reproducción con la aplicación / Setup e riproduzione con app /
Einrichtung und Wiedergabe per App / Installen en Afspelen met App / Настройка и воспроизведение через приложение

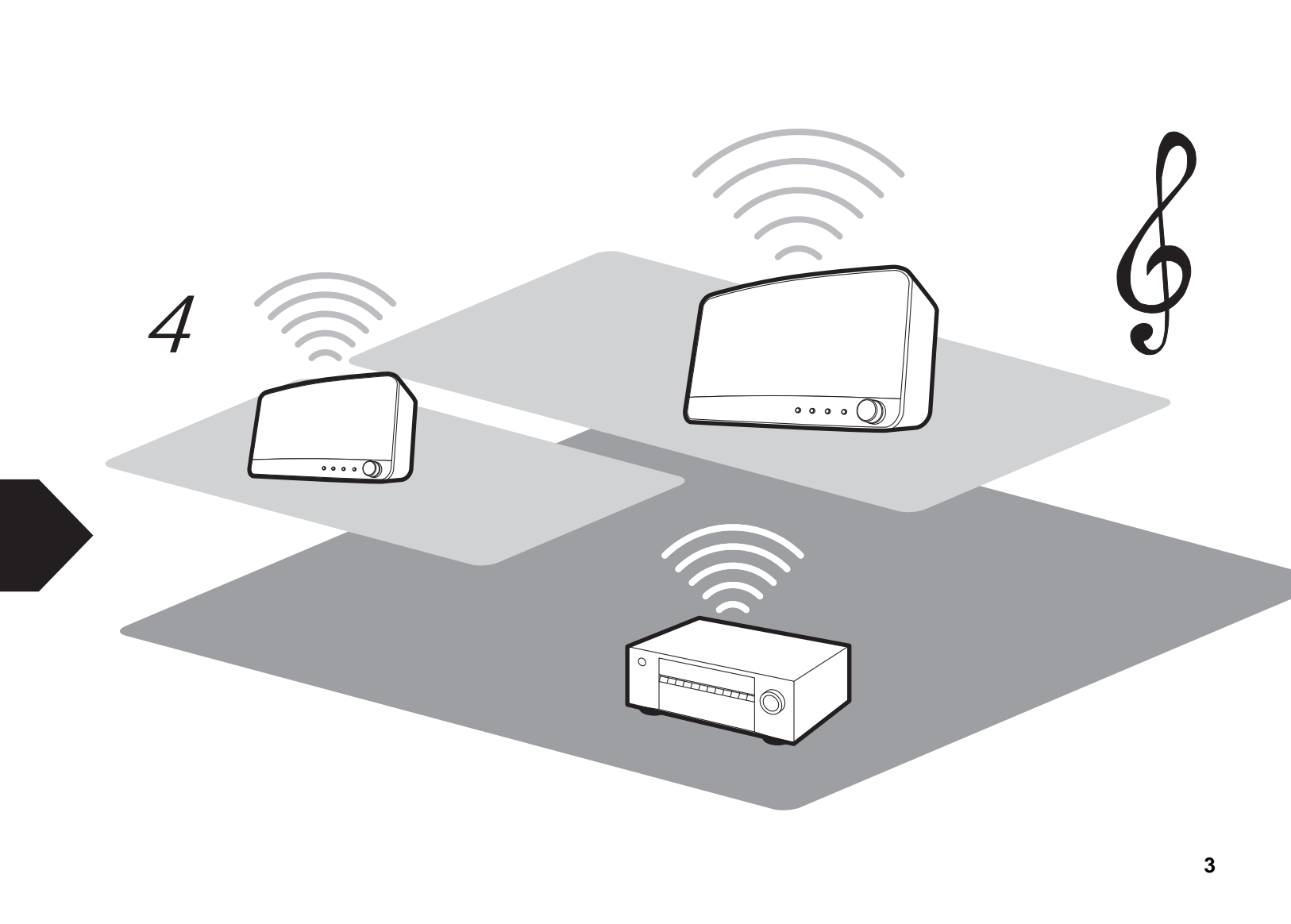

Bluetooth® Pairing & Play

Pairing

Appairage / Emparejamiento /
Abbinamento / Kopplung / Pairen /
Сопряжение

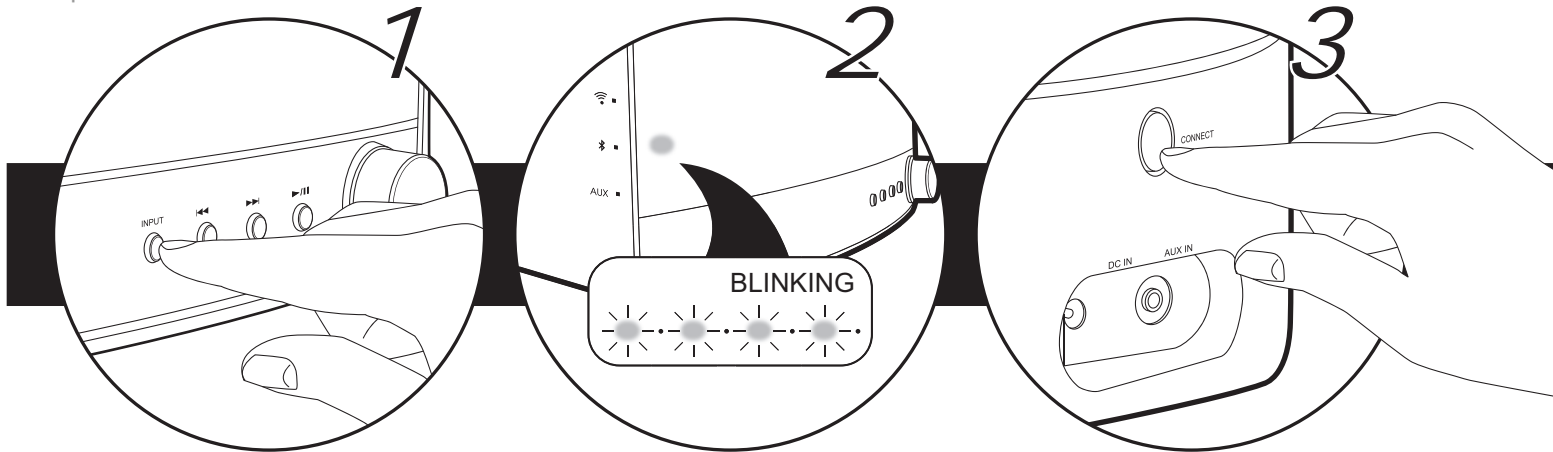

Appairage & Lecture Bluetooth / Emparejamiento de Bluetooth y reproducción / Abbinamento e riproduzione Bluetooth /
Bluetooth-Kopplung und -Wiedergabe / Bluetooth Pairen en Afspelen / Сопряжение Bluetooth и воспроизведение

Play

Lecture / Reproduccion / Riproduzione /
Wiedergabe / Afspelen / Воспроизведение

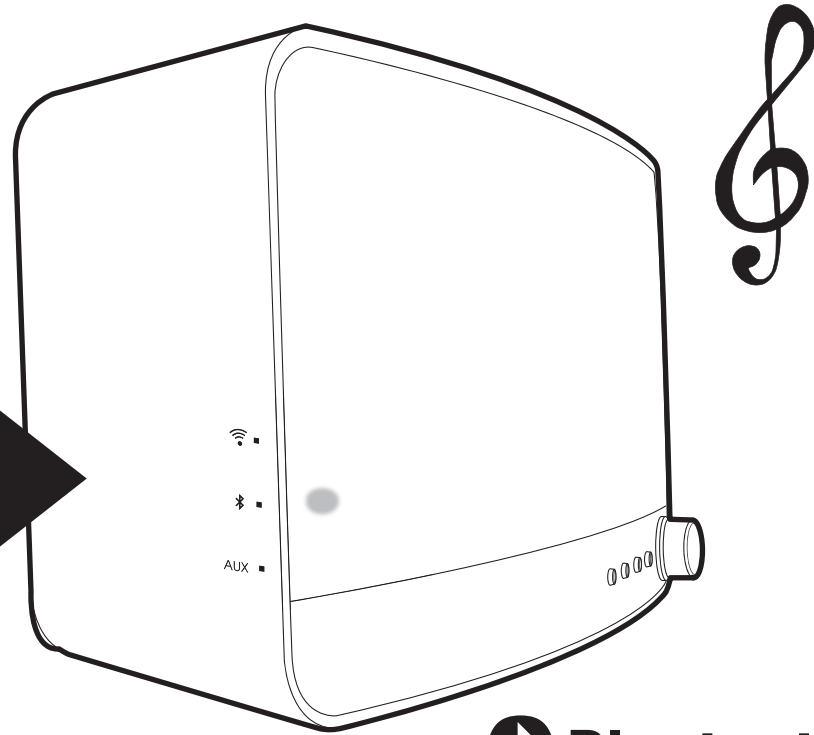
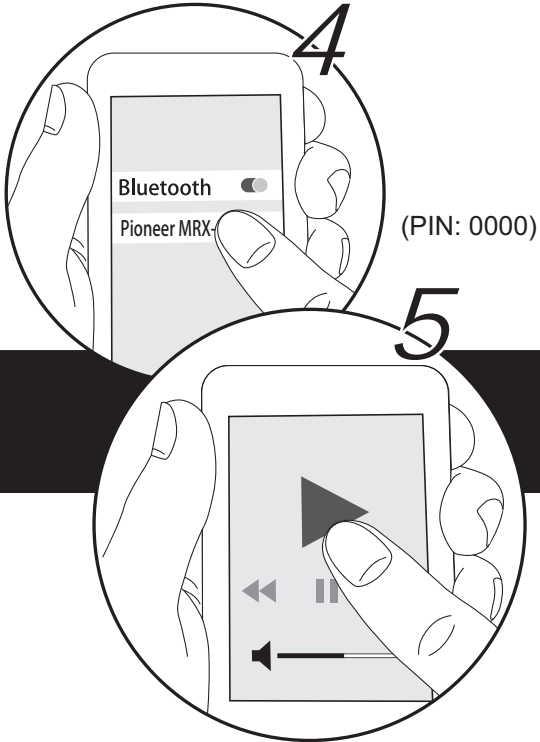

AUX Input

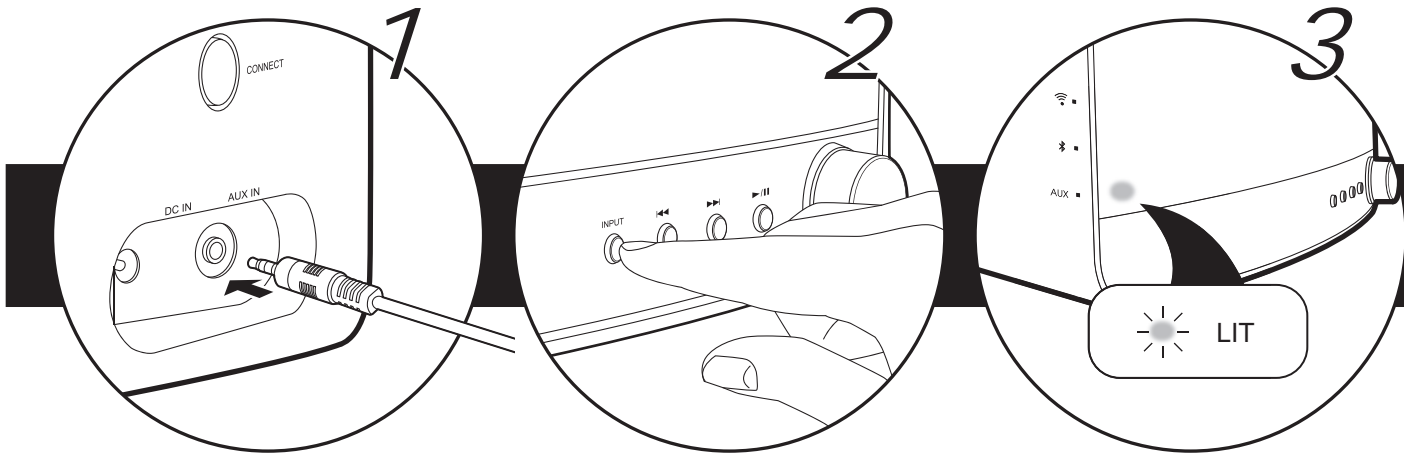

Entrée AUX / Entrada AUX / Ingresso AUX / AUX-Eingang / AUX-ingang / Вход AUX

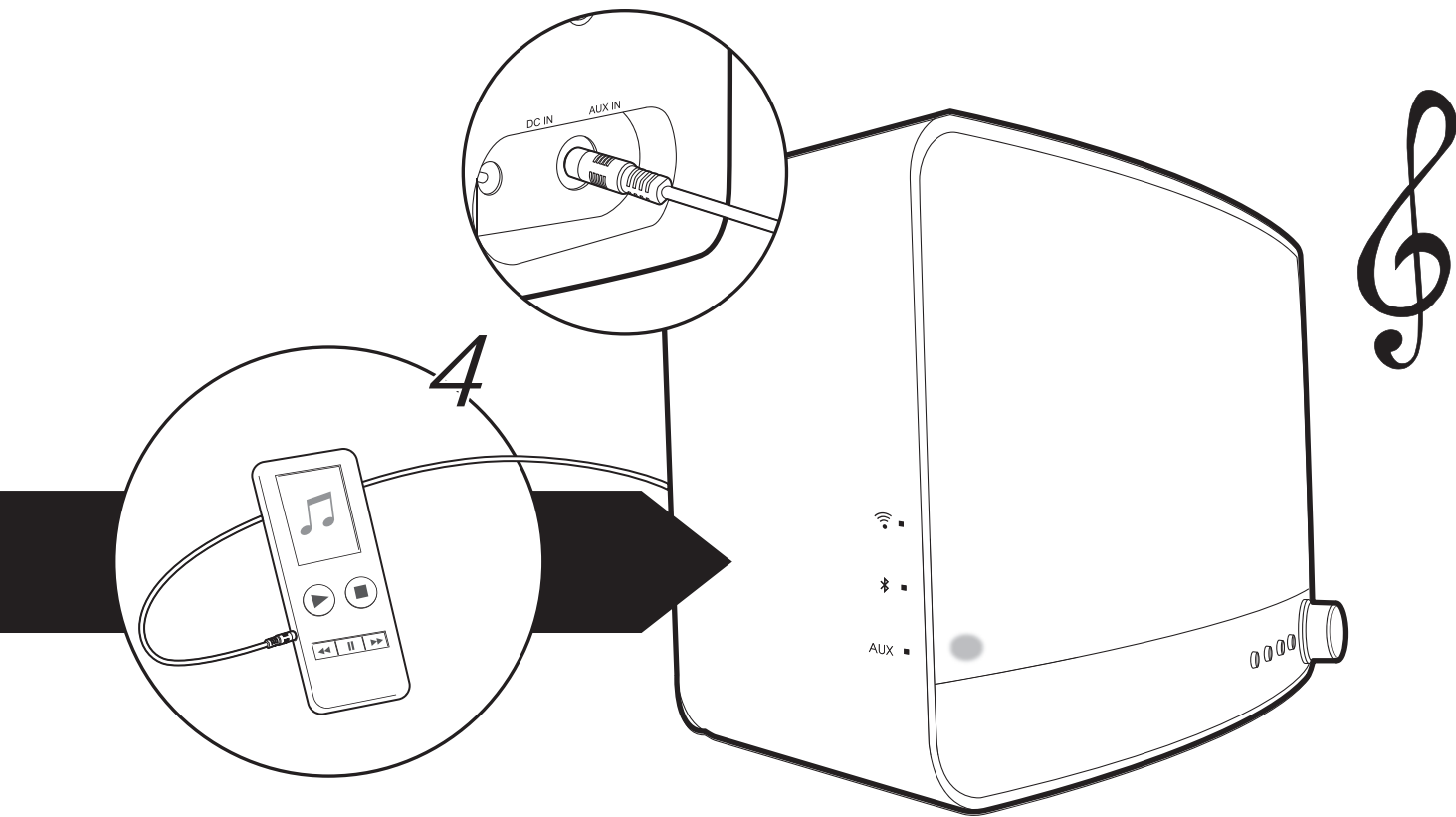

About **Buttons & Connections**

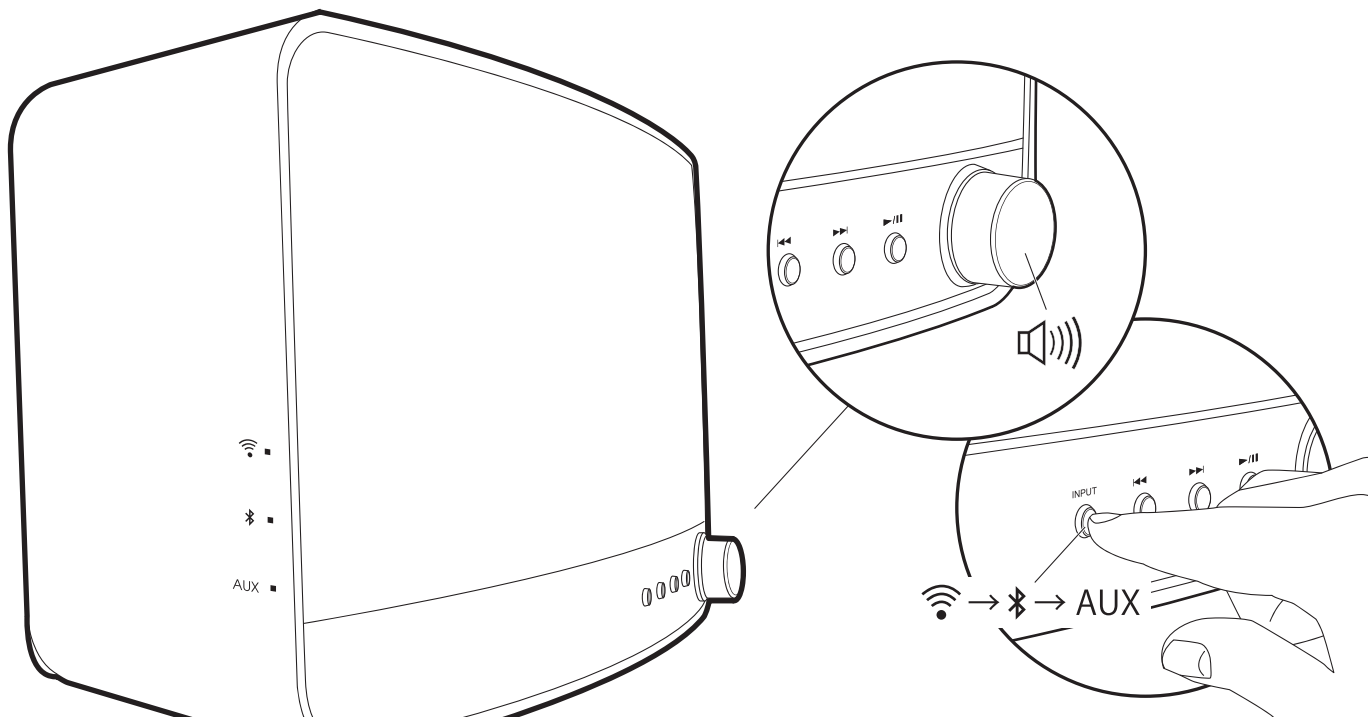

À propos des touches et des connexions / Acerca de los botones y las conexiones / Informazioni su pulsanti e collegamenti / Informationen zu Tasten und Verbindungen / Over Knoppen en Verbindingen / Кнопки и соединения

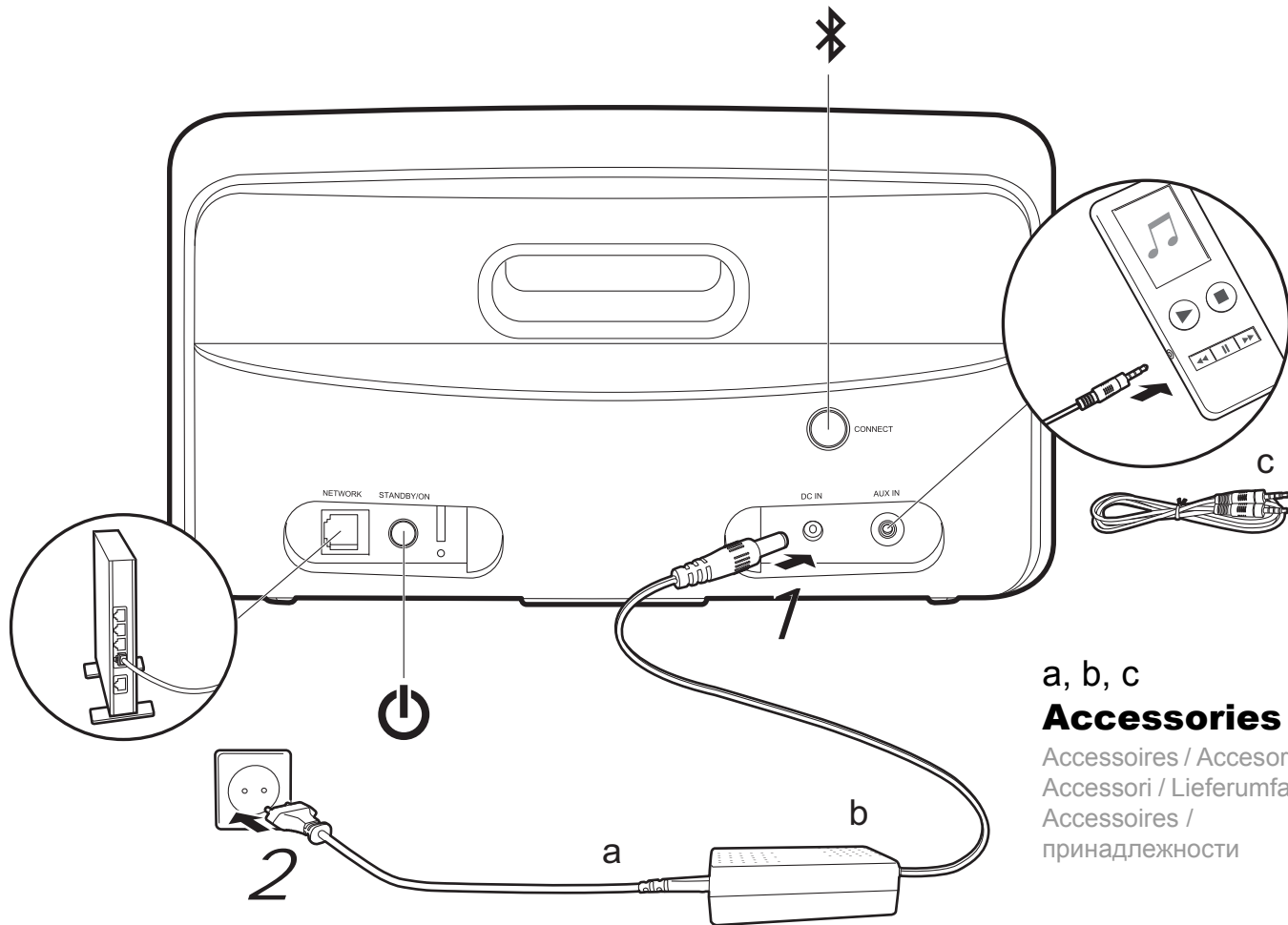

a, b, c
Accessories

Accessoires / Accesorios /
Accessori / Lieferumfang /
Accessoires /
принадлежности

Advanced Manual / Q&A found here



[http://www.pioneer-audiovisual.com/
manual/mrx/adv.pdf](http://www.pioneer-audiovisual.com/manual/mrx/adv.pdf)

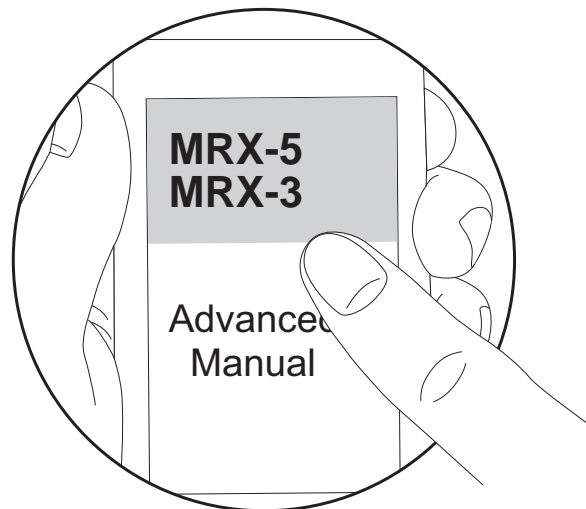

Mode d'emploi avancé/Q&R se trouvent ici / El Manual avanzado/P&R lo puede encontrar aquí / Manuale avanzato/
Domande e risposte si trovano qui / Erweiterte Bedienungsanleitung/Fragen und Antworten hier erhältlich / Geavanceerde
Gebruiksaanwijzing/Vragen en Antwoorden hier beschikbaar / Здесь находится расширенное руководство/вопросы и
ответы



The Wi-Fi CERTIFIED Logo is a certification mark of Wi-Fi Alliance®.



The Bluetooth® word mark and logos are registered trademarks owned by the Bluetooth SIG, Inc.



Apple and the Apple logo are trademarks of Apple Inc., registered in the U.S. and other countries. App Store is a service mark of Apple Inc.



Google Play, Google Play logo are trademarks of Google Inc.



This Mark Certifies that this product is compliant with the BLACKFIRE ALLIANCE Standard. Please refer to WWW.BLACKFIREALLIANCE.COM for more information. BLACKFIRE RESEARCH is a Registered Trademark of BLACKFIRE RESEARCH CORP. All rights reserved.



FireConnect™ is technology powered by BlackFire Research.

Pioneer

2-3-12 Yaesu, Chuo-ku, Tokyo 104-0028 JAPAN

<U.S.A.>

18 PARK WAY, UPPER SADDLE RIVER, NEW JERSEY 07458, U.S.A.

Tel: 1-201-785-2600 Tel: 1-844-679-5350

<Germany>

Hanns-Martin-Schleyer-Straße 35, 47877 Willich, Germany

Tel: +49(0)2154 913222

<UK>

Anteros Building, Odyssey Business Park, West End Road, South Ruislip,
Middlesex, HA4 6QQ United Kingdom

Tel: +44(0)208 836 3612

<France>

6, Avenue de Marais F - 95816 Argenteuil Cedex FRANCE

Tel: +33(0)969 368 050

Корпорация О энд Пи

2-3-12, Яэсу, Чюо-ку, г. Токио, 104-0028, ЯПОНИЯ

© 2016 Onkyo & Pioneer Corporation. All rights reserved.

© 2016 Onkyo & Pioneer Corporation. Tous droits de reproduction et de traduction réservés.

"Pioneer" is a trademark of Pioneer Corporation, and is used under license.

Printed in China / Imprimé en Chine / Напечатано в Китае

SN 29402553

F1604-0



* 2 9 4 0 2 5 5 3 *